

ARKITEK



ACTIU

ARKITEK

Elegancia arquitectónica

Contents:

**The importance
of caring for
forms**

**New spaces for
new leaders**

**Cutting-edge
and versatility on
display**

“Architecture means building, order, it is the wonderful play of volumes under light, foundations to which we have gone back to as a starting point to conceive Arkitek”.



ALEGREDESIGN
Marcelo Alegre

“La arquitectura es el hecho de construir, es orden, es el juego magnífico de los volúmenes bajo la luz, fundamentos a los que nos remontamos como punto de partida para la concepción de Arkitek”.

“L’architecture est l’acte de construire, c’est l’ordre, c’est le magnifique jeu des volumes sous la lumière, les fondements auxquels on revient comme point de départ pour la conception d’Arkitek ”.

“Architektur bedeutet Bauen und Ordnung. Es ist das wunderbare Spiel der Formen unter dem Licht - das Fundament, auf das wir als Ausgangspunkt zurückgegangen sind um Arkitek zu konzipieren”.



THE IMPORTANCE OF
CARRYING FOR FORMS



Our Arkitek range shares a technical and artistic concept with architecture. The organic shapes of its sturdy structure, made entirely of aluminium, give the range its unique avant-garde and contemporary feel.

Nuestro programa Arkitek comparte con la arquitectura una concepción técnica y artística. Las formas orgánicas de su robusta estructura, fabricada íntegramente en aluminio, aportan al programa su inconfundible carácter vanguardista y contemporáneo.

Notre programme Arkitek partage une conception technique et artistique avec l'architecture. Les formes organiques de sa structure robuste, entièrement en aluminium, confèrent au programme un caractère d'avant-garde et contemporain unique.

Unser Arkitek-Programm teilt mit der Architektur eine technische und künstlerische Konzeption. Die organischen Formen seiner robusten, ganz aus Aluminium gefertigten Struktur verleihen dem Programm seinen unverwechselbaren avantgardistischen und zeitgenössischen Charakter.







Arkitek comes in numerous structure finishes: aluminium, white, black, polished and chrome.

Arkitek se ofrece en diversos acabados de estructura: aluminizado, blanco, negro, pulido y cromado.

Arkitek est proposé en différentes finitions de cadre : aluminium, blanc, noir, poli et chromé.

Arkitek ist in verschiedenen Gestellausführungen erhältlich: Aluminium in Weiß, Schwarz, Poliert und Verchromt.



NEW SPACES FOR
NEW LEADERS



The new generation of CEOs require modern offices adapted to current times. Arkitek is the furniture solution capable of providing an avant-garde and customised touch, through design, to the workspaces run by modern leaders.

Las nuevas generaciones de directivos precisan de nuevos despachos adaptados a los nuevos tiempos. Arkitek es la solución de mobiliario capaz de aportar vanguardia y personalidad a través del diseño a los espacios de trabajo de los nuevos líderes.

Les nouvelles générations de dirigeants ont besoin de nouveaux bureaux adaptés aux temps nouveaux. Arkitek est la solution de mobilier capable d'apporter avant-garde et personnalité à travers le design aux espaces de travail des nouveaux dirigeants.

Die neue Generation von Managern benötigt moderne und der heutigen Zeit angepasste Büros. Arkitek ist die Einrichtungslösung, die eine avantgardistische und maßgeschneiderte Individualität in die Arbeitsräume der Führungskräfte einbringt.



Arkitek shows off its most exclusive side in employee and executive offices. The use of organic shapes gives it a contemporary and elegant personality that goes perfectly with the Noom armchairs.

Arkitek muestra su lado más exclusivo en despachos personales y de dirección. El empleo de formas orgánicas otorga un carácter contemporáneo y elegante que combina perfectamente con los sillones Noom.

Arkitek montre son côté le plus exclusif dans des bureaux personnels et de direction. L'utilisation de formes organiques confère un caractère contemporain et élégant qui s'adapte parfaitement aux fauteuils Noom.

Arkitek zeigt sich von seiner exklusivsten Seite in Einzel- und Chefbüros. Die Verwendung von organischen Formen verleiht ihm eine zeitgemäße und elegante Persönlichkeit, die sich perfekt mit Noom Sesseln kombinieren lässt.









Young entrepreneurs or founders of technology companies represent the generational change that is defining new leadership models. Head offices are evolving to accommodate new business values, such as innovation or dynamism, which seek to come across in modern spaces that reflect a clear commitment to design.

Jóvenes emprendedores o fundadores de empresas tecnológicas representan el cambio generacional que está definiendo un nuevo modelo de liderazgo. Los despachos de dirección evolucionan para dar cabida a nuevos valores empresariales, como la innovación o el dinamismo, que buscan ser reflejados en espacios modernos que apuestan abiertamente por el diseño.

Les jeunes entrepreneurs ou fondateurs d'entreprises technologiques représentent le changement de génération qui définit un nouveau modèle de leadership. Les bureaux de direction évoluent pour s'adapter aux nouvelles valeurs de l'entreprise, telles que l'innovation ou le dynamisme. Et celles-ci doivent se refléter dans des espaces modernes qui misent ouvertement sur le design.

Jungunternehmer oder Gründer von Technologieunternehmen repräsentieren den Generationswechsel, der neue Führungsmodelle definiert. Die Firmenzentralen entwickeln sich weiter um neue Unternehmenswerte wie Innovation und Dynamik in modernen Räumen zum Ausdruck zu bringen und ein klares Bekenntnis zum Design widerzuspiegeln.

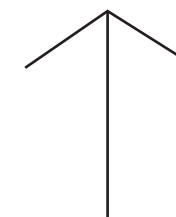

Private spaces for setting up meetings, holding telephone calls or videoconferences, or internal team meetings are still required by modern managers. With Arkitek's accessories, the space optimises all its possibilities, leading to greater productivity.

Los espacios privados para concertar visitas, tener conversaciones telefónicas o de conferencias, o reuniones con los equipos internos siguen siendo una necesidad para los nuevos directivos. Con los accesorios de Arkitek, el espacio optimiza todas sus posibilidades para ofrecer una mayor productividad.



Les espaces privés constituent toujours une nécessité pour les nouveaux managers afin d'organiser des visites, des conversations téléphoniques, des conférences, ou des réunions avec des équipes internes. Avec les accessoires Arkitek, nous optimisons l'espace au travers de toutes ses possibilités pour offrir une plus grande productivité.

Private Bereiche, in denen Besuche arrangiert, Telefon- oder Konferenzgespräche geführt oder Sitzungen mit internen Teams abgehalten werden, sind nach wie vor eine Notwendigkeit für neue Führungskräfte. Mit dem Zubehör von Arkitek optimiert der Raum alle seine Möglichkeiten, um eine höhere Produktivität zu bieten.

C U T T I N G - E D G E
A N D V E R S A T I L I T Y
O N D I S P L A Y



The layouts offered by the Arkitek range are aimed at office environments, such as executive desks, meeting tables or desks.

Las configuraciones que ofrece el programa Arkitek están orientadas a cubrir los distintos ámbitos de la oficina, como mesas de dirección, mesas de reunión o mesas de trabajo.

Les configurations proposées par le programme Arkitek ont pour objectif de couvrir les différentes zones des bureaux, telles que les tables de direction, les tables de réunion ou les tables de travail.

Die im Arkitek-Programm angebotenen Konfigurationen sind darauf ausgerichtet, die verschiedenen Funktionen innerhalb der Arbeitsumgebung abzudecken, z.B. fokusorientierte Manager-Schreibtische, Besprechungstische oder operative Bench-Lösungen.

Total solution

The meeting and auxiliary tables that are part of the range allow for the creation of personal meeting areas that are close to the workstation. Block offers high-quality filing solutions and a design that complements the Arkitek range. It has different sizes of cabinets, auxiliary modules adjacent to the table, as well as fixed and wheeled bucks. Arkitek with support over filing or Block converts itself into an elegant and practical combination, providing total functionality and greater organisation to workspaces.

Solución total

Las mesas de reunión y auxiliares que componen el programa permiten crear zonas de reunión personales próximas al puesto de trabajo. Block ofrece soluciones de archivo con un nivel cualitativo y un diseño que complementa al programa Arkitek. Dispone de diferentes medidas de armarios, módulos auxiliares contiguos a mesa, así como bucks fijos y con ruedas. Arkitek con apoyo sobre archivo o block se convierte en una combinación tan sobria como práctica, aportando total funcionalidad y mayor organización a los espacios de trabajo.



Solution intégrale

Les tables de réunion et les tables d'appoints qui composent le programme permettent la création d'espaces de réunion personnels à proximité du poste de travail. Block propose des solutions de classement avec un niveau qualitatif et une conception qui complète le programme Arkitek. Il offre différentes options d'armoires, de modules d'appoint adjacents à la table, ainsi que des armoires fixes et à roues. Arkitek avec support sur meuble de classement, ou Block devient une combinaison aussi sobre que pratique, offrant une fonctionnalité complète et une plus grande organisation des espaces de travail.

Integrale Lösungen

Die Arkitek Besprechungs- und Beistelltische ermöglichen die Schaffung von persönlichen Besprechungsbereichen in der Nähe des Arbeitsplatzes. Block bietet hochwertige Ablagelösungen und ein Design, welches das Arkitek-Programm ideal ergänzt. Es hat verschiedene Größen von Sideboards, Zusatztischmodulen, sowie feste und mobile Caddys. Arkitek im Zusammenspiel mit dem Block Programm verwandelt sich in eine elegante und praktische Kombination und bietet totale Funktionalität und eine optimale Organisation des Arbeitsplatzes.

Arkitek enables the incorporation of shared and independent wings for progressive working positions, as well as glass, phenolic and aluminium modesty panels; functional elements for positions with representative functions and customer-facing roles.

Arkitek permite la incorporación de alas compartidas e independientes para puestos operativos de progresión, así como faldones de vidrio, fenólico y aluminio; elementos funcionales para puestos con funciones representativas y de atención al público. organización a los espacios de trabajo.



Arkitek permet l'intégration d'ailes partagées et indépendantes pour les postes de travail de progression, ainsi que des voiles de fond en verre, en hpl compact et en aluminium ; des éléments fonctionnels pour les postes avec des fonctions de représentation et de service client.

Arkitek ermöglicht die Einbindung von geteilten und unabhängigen Erweiterungstischen für progressive Arbeitspositionen, Glas-, Vollkern- und Metallknieraumblenden sowie weitere Funktionselemente.



Arkitek enables creating operative working layouts with shared structures for two and four-seater tables. These structures integrate a full electrification system that facilitates installing and channelling the cabling.

Arkitek permite crear configuraciones de trabajo operativo con estructuras compartidas para mesas dobles y cuádruples. Estas estructuras integran un completo sistema de electrificación que facilita la instalación y canalización del cableado.

Arkitek permet de créer des configurations de travail opérationnelles avec des structures partagées sur les bench deux personnes et quatre personnes. Ces structures intègrent un système d'électrification complet qui facilite l'installation et la canalisation du câblage.

Arkitek ermöglicht als Bench-Lösung vielfältige operative Arbeitslayouts. Das Tischgestell verfügt über ein vollständiges Elektrifizierungssystem das die Installation und Führung der der Verkabelung erleichtert.



**Good interior designers
They don't just scratch the
surface: they go deeper.**

**Los buenos interioristas
No se quedan en la superficie:
se enamoran de ella.**

**Les bons designers d'intérieur
Ils ne restent pas à la surface :
ils en tombent amoureux.**

**Gute Innenarchitekten
Sie bleiben nicht nur auf der
Oberfläche: Sie werden sich
direkt in sie verlieben.**

As a result of our collaboration with Cosentino, Arkitek offers its most avant-garde side with Dekton®, a technological material composed of porcelain, glass and quartz that has enabled us to include the first stone surface in an Actiu range.

Fruto de nuestra colaboración con Cosentino, Arkitek ofrece su versión más vanguardista con Dekton®, un material tecnológico compuesto por porcelana, vidrio y cuarzo que nos ha permitido incluir la primera superficie pétrea en un programa de Actiu..

Grâce à notre collaboration avec Cosentino, Arkitek propose sa version la plus avant-gardiste avec Dekton®, un matériau technologique composé de porcelaine, de verre et de quartz qui nous a permis de proposer la première surface en pierre dans un programme Actiu.

Als Ergebnis unserer Kooperation mit Cosentino, bietet Arkitek eine besonders avantgardistischste Version mit Dekton®, einem High-Tech-Material, das aus Porzellan, Glas und Quarz besteht. Es ermöglicht uns die erste Steinoberfläche als Tischplattenmaterial in eine Actiu-Produktprogramm aufzunehmen.



TECHNICAL FEATURES

Información técnica

La estructura, fabricada íntegramente en aluminio, es el resultado de un amplio desarrollo de ingeniería que dota al programa de una gran flexibilidad para configurar mesas individuales, dobles o de progresión.

The structure, made entirely of aluminum, is the result of extensive engineering development that gives the program great flexibility to configure individual, double and progressive desks.

Arkitek est un programme de tables qui répond à une vision architectonique de l'aménagement des bureaux. Des modèles qui offrent des solutions opérationnelles avec un design singulier et des matériaux de grande qualité.

Das vollständig aus Aluminium gefertigte Gestell basiert auf einer umfassenden Entwicklungsarbeit. Dadurch offeriert das Programm eine hohe Flexibilität, um erweiterbare Arbeitsplätze für ein, zwei oder mehr Personen zusammenzustellen.



1 Steel or melamine modesty panels / Faldón de chapa o melamina

2 Flip up cable access / Acceso de Cableado

3 Cable trays / Canales electrificación

4 Upholstered and accoustic desktop screens / Divisoria Tapizada y Foamizada

5 Moulded aluminium supports including rubber pads to hold the worktops

Brazos de aluminio con disco de apoyo para superficies de vidrio

6 Aluminium levellers with anti-skid pad

Niveladores de aluminio con soleta antideslizante

FRAME FINISH OPTIONS

Acabados de estructura

Moulded aluminium legs and extruded aluminium beams.

Las patas están fabricadas en aluminio inyectado y los travesaños en aluminio extrudido.

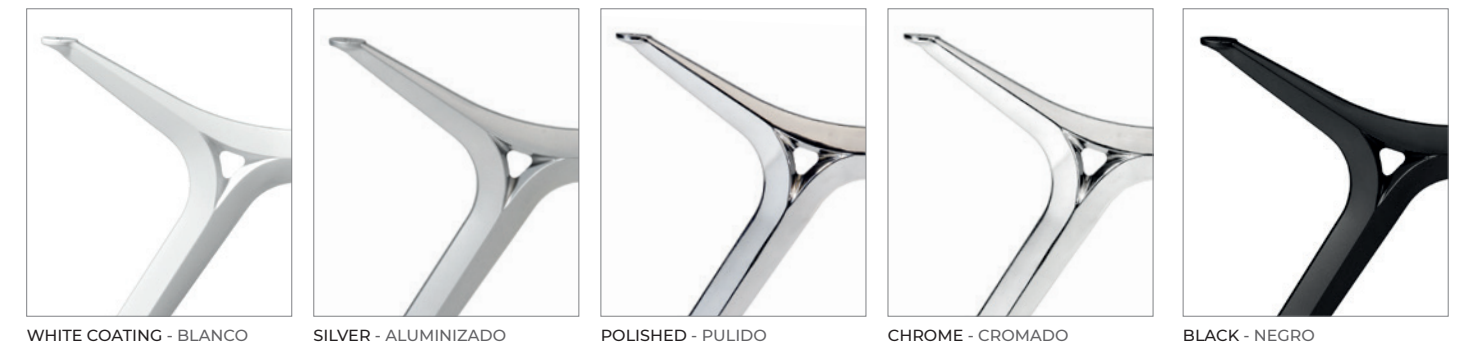

SURFACE FINISH OPTIONS

Acabados de superficies

MELAMINA - MELAMINE

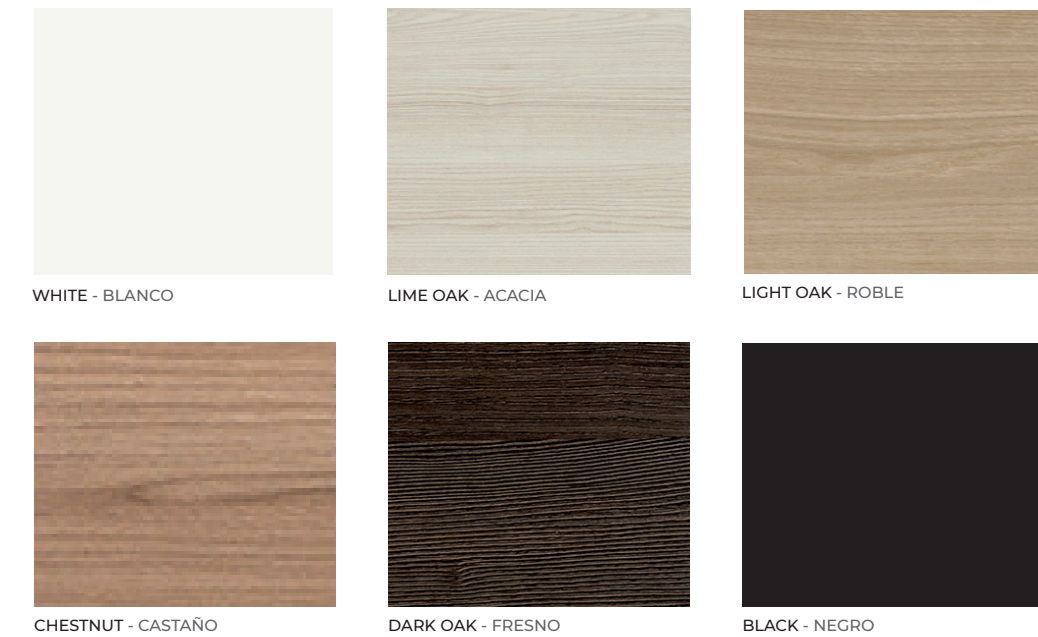

C. LAMINATE - FENOLICO



LAMINATED SCURITY GLASS - VIDRIO DE SEGURIDAD LAMINADO



INDIVIDUAL AND EXECUTIVE DESKS - MESAS INDIVIDUALES Y DE DIRECCIÓN

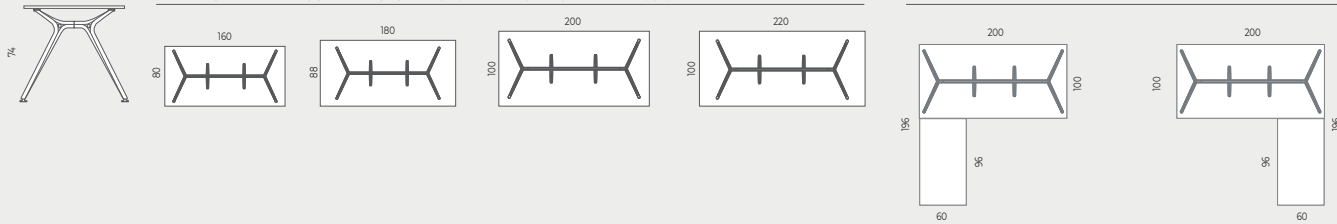

EXECUTIVE DESK SUPPORTED BY BLOCK STORAGE UNIT - MESAS DIRECCIÓN CON APOYO EN BLOCK

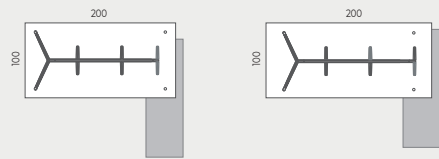

TWIN DESKS WORKSTATION - MEETING TABLES - WIDTH - 140/160 cm - MESAS DOBLES OPERATIVAS - MESAS DE REUNIÓN - ANCHO 140/160 cm

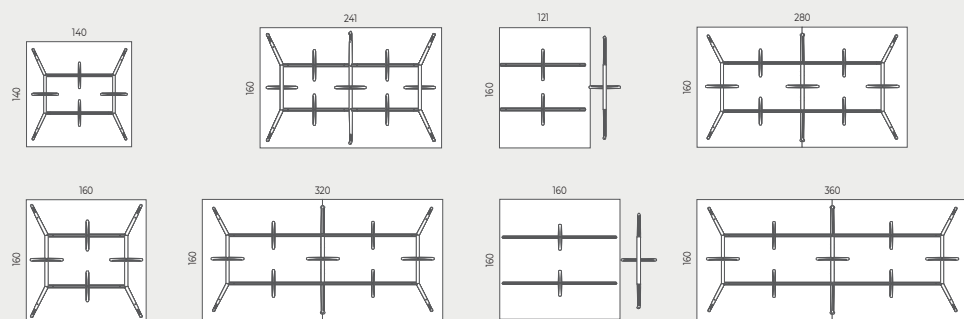

MEETING TABLES - WIDTH - 120 cm - MESAS DE REUNIÓN - ANCHO 120 cm

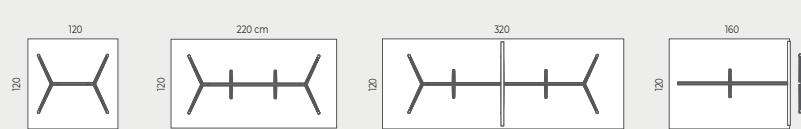

MEETING TABLES - MESAS AUXILIARES

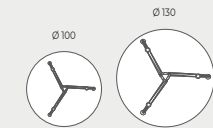

DESK SUPPORTED BY SPINE STORAGE UNIT - MESAS CON APOYO EN MODULO SPINE

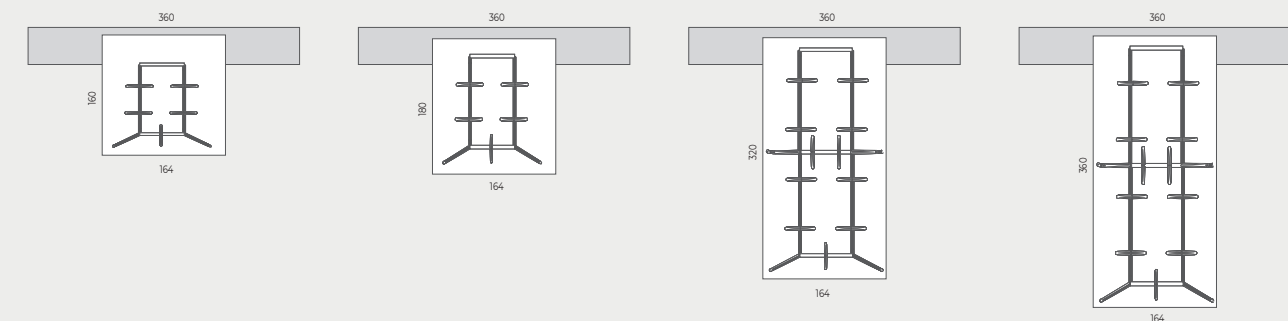



ACTIU TECHNOLOGY PARK

DESIGN & ARCHITECTURE

Space management and design
Products. Own patents
Communication

SUSTAINABILITY

Sustainable production
Product. Eco-design
Services, efficient logistics system
Actiu Technology Park, certified LEED®
Platinum

MANUFACTURER

We are manufacturers
Domain raw materials and processes
Technology and Innovation
Standardized and specific solutions

GLOBAL COVERAGE

Presence in more than 90 countries
Global equipment solutions. Corporate, Health,
Education, Contract, Transport.

CERTIFICATES AND REFERENCES

ACTIU products fulfill all demands about management, quality and sustainability to provide extra value to the projects using recycled materials to get the recyclable final product.



Actiu, the first industrial company in the world to obtain the **WELL v2 and LEED Platinum Certification**

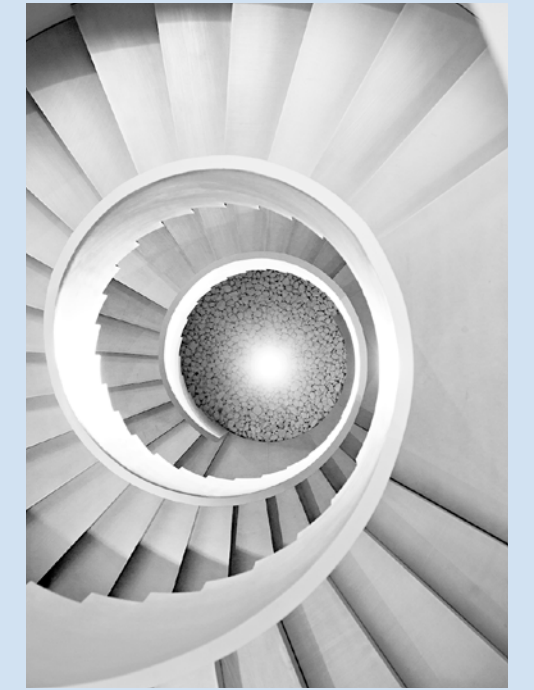

ACTIU: 50 YEARS DESIGNING PUBLIC SPACES AND WORKSPACES.

Actiu is an industrial company working within the installation sector and specialising in the manufacture of furniture. Actiu's flexibility and productive capacity enable the company to carry out comprehensive equipment projects worldwide, providing solutions that favour the wellbeing of people.

ACTIU, 50 AÑOS DISEÑANDO ESPACIOS PÚBLICOS Y DE TRABAJO.

Actiu es una empresa con una trayectoria industrial en el sector de la instalación, especializada en la creación de mobiliario, cuya flexibilidad y capacidad productiva permite desarrollar proyectos de equipamiento global a nivel internacional aportando soluciones que ofrezcan el bienestar de las personas.

ACTIU, 50 AÑOS DISEÑANDO ESPACIOS PÚBLICOS Y DE TRABAJO.

Actiu est une entreprise dotée d'un parcours à caractère industriel dans le secteur de l'installation, qui se spécialise dans la création de mobilier, et dont la flexibilité et la capacité de production permettent de développer des projets d'équipement global à un niveau international, tout en apportant des solutions qui puissent offrir du bien-être aux personnes.

ACTIU, 50 JAHRE DESIGN UND PRODUKTION VON MÖBELN FÜR ÖFFENTLICHE EINRICHTUNGEN UND ARBEITSRÄUME.

Unsere ständige Forschung, Weiterentwicklung, Flexibilität und Erfahrung ermöglichen es uns, Projekte im privaten und öffentlichen Bereich der verschiedensten Sektoren auf nationaler und internationaler Ebene durchzuführen. Stillstand ist uns fremd. Uns treibt das Bedürfnis an, näher an den Menschen zu sein und Lösungsmöglichkeiten zu entwickeln, die den Endnutzern Wohlgefühl bieten.

ACTIU reserves the right to carry out technical, dimensional and finishing modifications that it considers appropriate with respect to the information detailed in this document, so please check before confirming your orders.

ACTIU se reserva el derecho de llevar a cabo las modificaciones técnicas, dimensionales y de acabados que estime conveniente respecto a la información detallada en este documento, por el que se ruega verificación antes de confirmar sus pedidos.

We dream to go beyond our own immediate reality. We design to mature our desires. We walk because only our initiative changes the world and breaks new ground. We move ourselves by being ourselves without the fear of underperforming against our own expectations and goals.

D. Vicente Berbegal Pérez

President and Founder of the Actiu Group.



ACTIU, National Design Award 2017
ACTIU, Premio Nacional de Diseño 2017

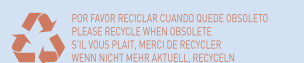

ARKITEK

By Alegre Design



INDIVIDUAL AND EXECUTIVE DESKS

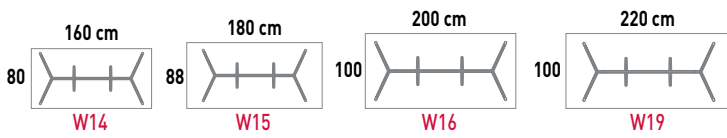

DESKS WITH RETURN SUPPORTED BY PEDESTAL UNIT

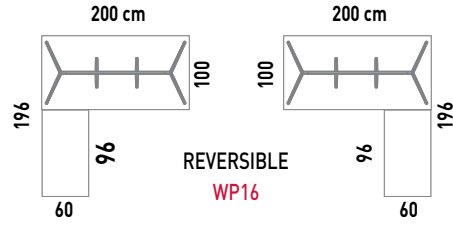

EXECUTIVE DESK SUPPORTED BY BLOCK STORAGE UNIT

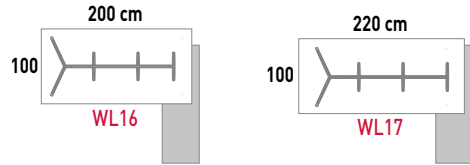

TWIN DESKS WORKSTATION - MEETING TABLES - WIDTH - 140/160 cm

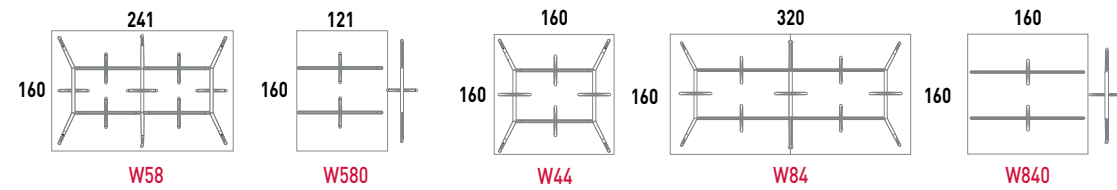

MEETING TABLES - WIDTH - 120 cm

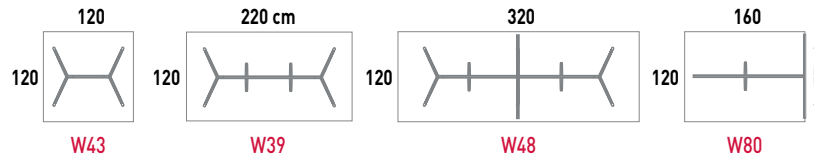

MEETING TABLES

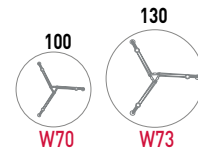

DESK SUPPORTED BY SPINE STORAGE UNIT

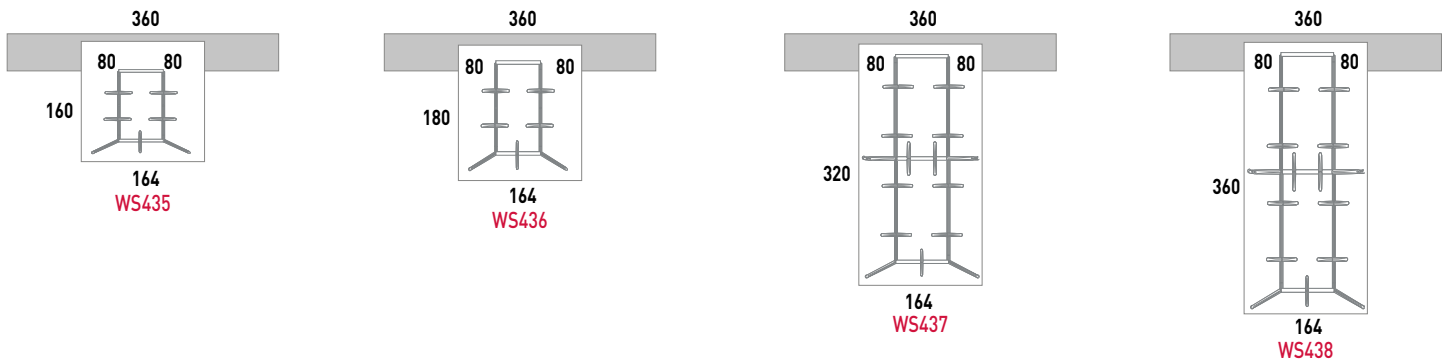

RECTANGULAR DESKS

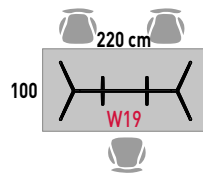
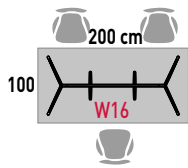

RECTANGULAR DESKS

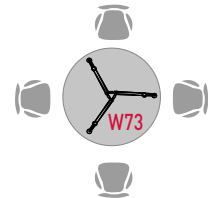
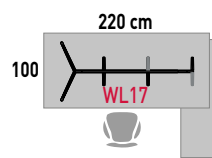
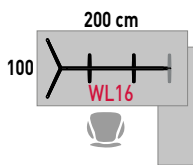

BENCH DESKING (PROGRESSIVE SYSTEM)

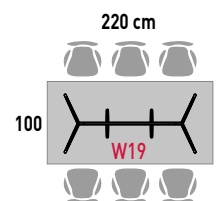
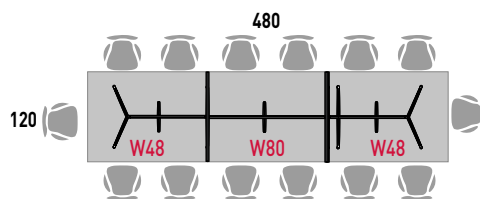
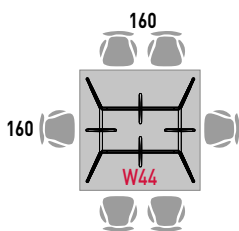

TWIN DESKS WORKSTATION

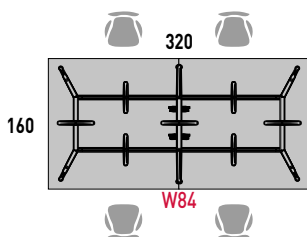

Single desks



Bench desks



■ DESK-TOP FINISHES

MFC (19 mm)



White Lime Oak Light Oak Chestnut Dark oak Black

antifingerprint

Compact Laminate (13 mm)



White

Laminated security glass (5+5/6+6 mm)



Clear Frosted Black

Tempered security glass (10 mm)



White

■ **FRAME**

Moulded aluminium legs and extruded aluminium beams.
Five different finishes: Silver, White or Black coating, Polished or Chrome



White coating Silver coating Polished Chrome Black

■ **LEG SUPPORTS**

Moulded aluminium leveller. Chrome.
Each leveller includes anti-skid pad.



Leveller - desk height: 74,5 cm

■ **ELECTRIFICATION SYSTEM**

Full length cable channel
with large capacity for cables. Easy access to the cables from the worktop.

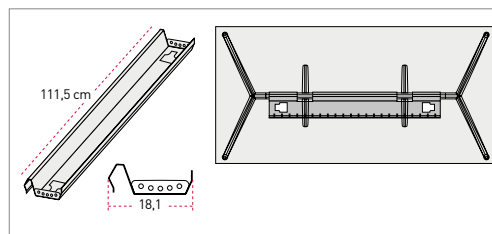

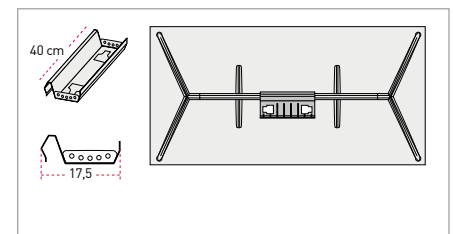

111,5cm Channel for individual use 180 and 200 cm desks.



40cm Channel for individual use 160, 180, 200 and 220cm desks

■ **CABLE ACCESS DESKS**

Q WIRING ACCESS	R WIRING ACCESS		
			
<p>MAXIMUM OPENING: 110°</p>	<p>MAXIMUM OPENING: 180°</p>		
<ul style="list-style-type: none"> • Black die-cast aluminium frame • Aluminum injected lid with soft-close retention system • Dimensions: 30,5 x 11,5 cm 	<ul style="list-style-type: none"> • Melamine lid of the same finish as the surface • Black Bristle Brush • Aluminum injected lid with soft-close retention system • Complete opening in 180° by means of hinges. • Dimensions: 30,5 x 11,5 cm 		



MATERIALS

Maximum use of materials to eliminate and minimize scraps. Use of recyclable and recycled materials in those components that do not affect the functionality and durability.

77,47%
RECYCLED
MATERIALS



PRODUCTION

Maximum optimization of energy use. Minimal environmental impact. Last generation technological systems. Zero discharge of wastewater. No VOC coatings. Processes free of heavy metals, phosphates, OC and COD.

100%
RECYCLABLE
ALUMINIUM, STEEL
& WOOD



TRANSPORT

Detachable systems. Volumes that facilitate the optimization of space. Maximum reduction of energy consumption by transport.

100%
RECYCLABLE
PACKAGE AND THINNER
FREE



USE

Quality and warranty. Long lasting. Replacements available.

EASY
TO CLEAN
AND MAINTAIN



DISPOSAL

Waste reduction. Supplier-manufacturer packaging reuse system. Components are easy to be separated. Inks in packaging are water-based, without solvents.

98,54%
RECYCLABLE
MATERIALS

■ **CERTIFICATES AND REFERENCES**

The different programmes get points in different environmental categories to get the LEED certificate (sustainability, material and resources, water, energy and atmosphere, inner environment quality, innovation and design).



The mark of responsible forestry



EN ISO 14006:2011
ECODESIGN Certificate



UNE-EN ISO 9001:2008
ISO 9001 Certificate



UNE-EN ISO 14001:2004
ISO 14001 Certificate



California 93120
Compromise Formaldehyde Phase 2



ACTIU TECHNOLOGY PARK
LEED® PLATINUM certified by USGBC
Leadership in Energy & Environmental Design
LEED® Gold certified 2011 - LEED® Platinum certified 2017

■ **STANDARDS**

ARKITEK has passed tests done in our technical department as well as the tests done in **AIDIMA** the Technological Institute for furniture. The tests correspond to UNE standards and office desks:

- **UNE: EN 527-1:2011.** Office Furniture. Desks. **Part 1:** Dimensions.
- **UNE: EN 527-2:2017.** Office Furniture. Desks. **Part 2:** Requirements for safety, resistance and durability.
- **UNE: EN 15372:17.** Office Furniture. Strength, durability and safety. Requirements for domestic use desks. Office Furniture. Desks.
- **UNE: EN 1730:13.** Furniture. Tables. Test methods for the determination of stability, strength and durability.