

Bridge

Specification Guide

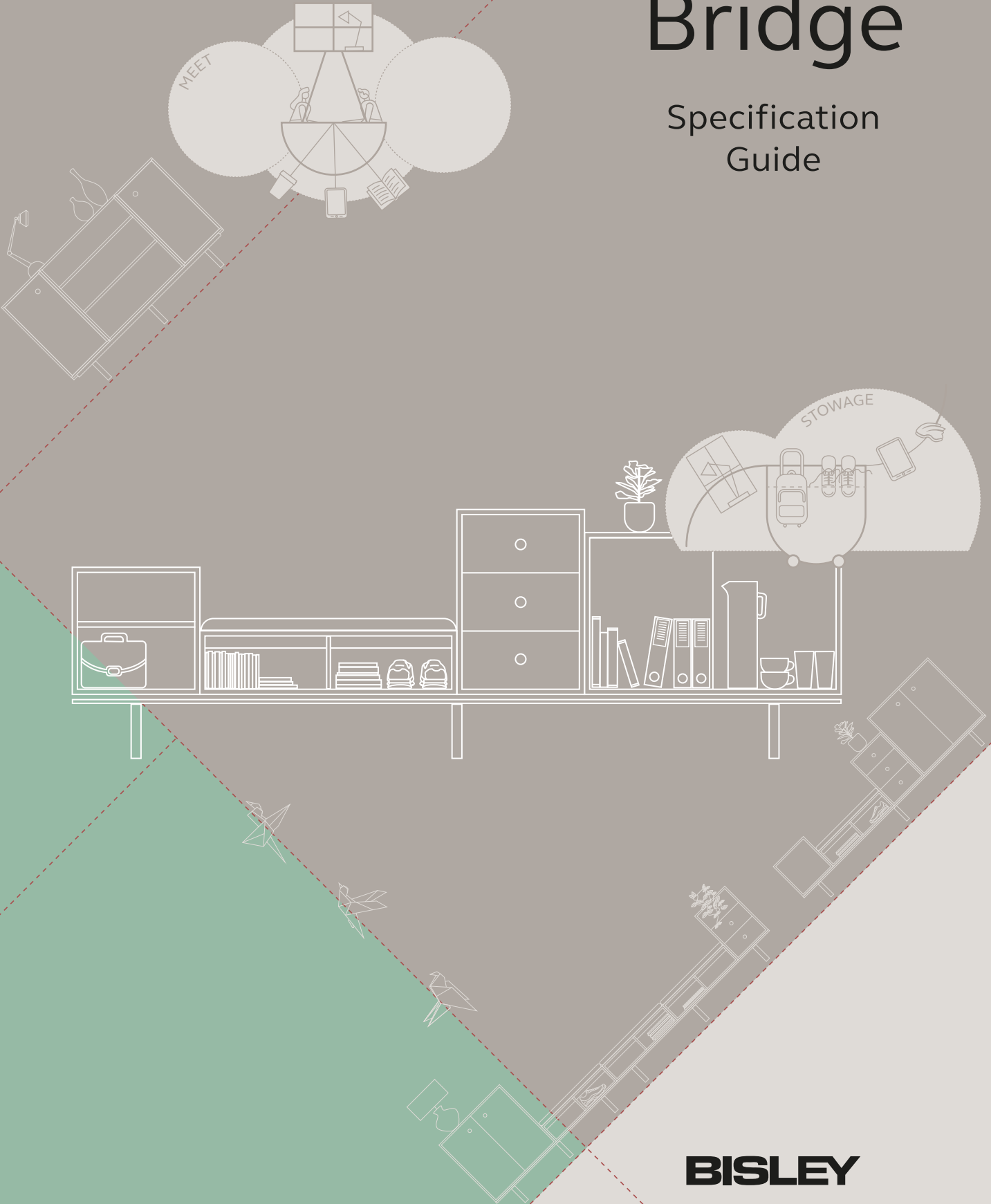

BISLEY

BRIDGE

Introducing Bridge by Bisley, the modern credenza that brings together storage, stowage and room division in one seamless system. Collaborating closely with Jones & Partners and inspired by the traditional meeting room credenza, Bridge has been re-imagined for the contemporary office and work styles, connecting flexible spaces together.

At Bisley, we understand your workday needs to flow. Bridge's versatility connects the workplace and you; from providing an impromptu place to perch, a stylish meeting room addition, subtle space division, or a relaxing place to recharge. Its breadth of steel colours, wood textures and vibrant fabrics means that the fun is in creating exactly what you imagined.



Your Specification Guide

This Bridge Specification Guide allows you to create and configure the perfect addition to your workplace.

Pages 4 to 25 showcase a collection of suggested settings split into Space Divider, Skyline and Meeting Room units. You have the freedom to change any part of the suggested setting by swapping out elements found in the Create Your Own and Accessories sections on pages 26-31 and 32-35.

If you would prefer to specify your own Bridge configuration from scratch, please find the Create Your Own section on pages 26-31. You can add different handles and accessories to your unit which are all detailed in the Accessories section on pages 32-35.

To order, pre-defined or your own configuration, you must specify finish options for each section of your Bridge unit. Please see pages 35-37 for more information.

Should you require any support specifying your Bridge unit, please contact your Bisley Representative.



 **P.04** SPACE DIVIDER

 **P.12** SKYLINE

 **P.20** MEETING ROOM CREDENZA

 **P.26** CREATE YOUR OWN

 **P.32** ACCESSORIES

 **P.35** FINISH OPTIONS

 **P.38** RANGE OVERVIEW

SPACE DIVIDER

Utilise Bridge's dual facing nature to create subtle space division or wayfinding through the workplace, with smart storage access from both sides.

Choose any Space Divider setting with the freedom to mix and match modules, finish options and accessories using the Create Your Own and Accessories sections on pages 26-35.





Space Divider settings

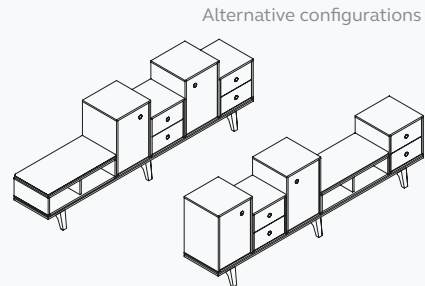
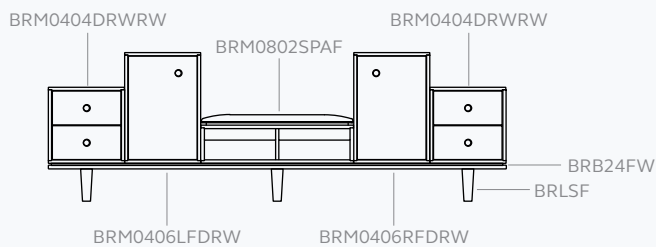

2400mm (94.5") wide, 400mm (15.7") deep

Code	Description	Width (mm)	Height (mm)
BRB24FW	Full width base	2400 (94.5")	30 (1.2")
BRLSF	Steel formed leg (set of three)	60 (2.4")	175 (6.9")
BRM0404DRWRW	Unit with two 182mm (7.2") drawers with round wood handles	400 (15.7")	400 (15.7")
BRM0406LFDRW	Full cupboard door, left hand open with round wood handle	400 (15.7")	582 (23")
BRM0802SPAF	Seat unit with fabric seat pad (see page 31 for seat pad fabric options)	800 (31.5")	255 (10")
BRM0406RFDRW	Full cupboard door, right hand open with round wood handle	400 (15.7")	255 (10")
BRM0404DRWRW	Unit with two 182mm (7.2") drawers with round wood handles	400 (15.7")	255 (10")

PLEASE NOTE to change handles, seat pad fabric, back panel finish or make top drawers lockable, please see pages 26-31 for alternative options and code swaps.

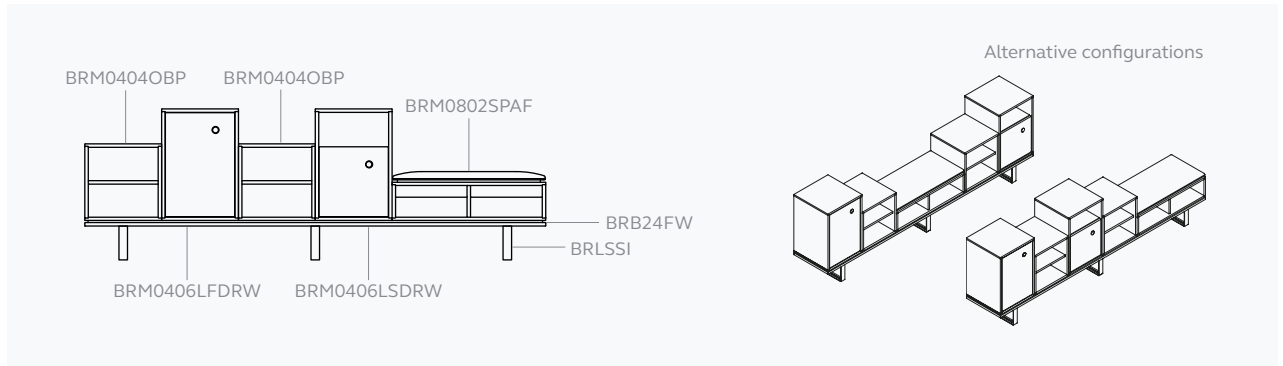

2400mm (94.5") wide, 400mm (15.7") deep

Code	Description	Width (mm)	Height (mm)
BRB24FW	Full width base	2400 (94.5")	30 (1.2")
BRLSSI	Steel skid leg (set of three)	44 (1.7")	175 (6.9")
BRM0404OBP	Shelf unit with one shelf	400 (15.7")	400 (15.7")
BRM0406LFDRW	Full cupboard door, left hand open with round wood handle	400 (15.7")	582 (23")
BRM0404OBP	Shelf unit with one shelf	400 (15.7")	400 (15.7")
BRM0406LSDRW*	Three quarter cupboard door, left hand open with round wood handle	400 (15.7")	582 (23")
BRM0802SPAF	Seat unit with fabric seat pad (see page 31 for seat pad fabric options)	800 (31.5")	255 (10")

*Three quarter door compatible with BRSIB0402 steel box insert. See page 35.

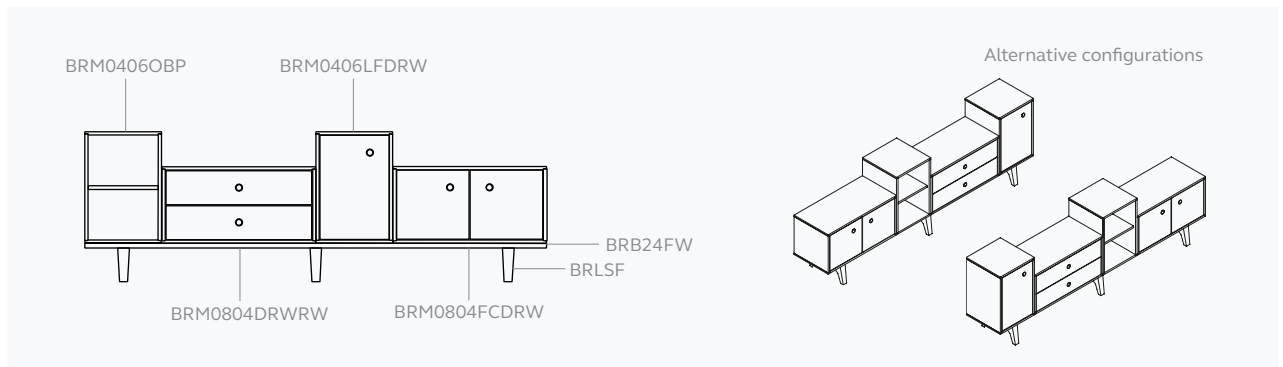

2400mm (94.5") wide 400mm (15.7") deep

Code	Description	Width (mm)	Height (mm)
BRB24FW	Full width base	2312 (91")	26 (1")
BRLSF	Steel formed leg (set of three)	60 (2.4")	175 (6.9")
BRM0406OBP	Shelf unit with one shelf	400 (15.7")	582 (23")
BRM0804DRWRW	Unit with two 182mm drawers with round wood handles	800 (31.5")	400 (15.7")
BRM0406LFDRW	Full cupboard door, left hand open with round wood handle	400 (15.7")	582 (23")
BRM0804FCDRW	Full double cupboard door with round wood handles	800 (31.5")	400 (15.7")

Space Divider settings

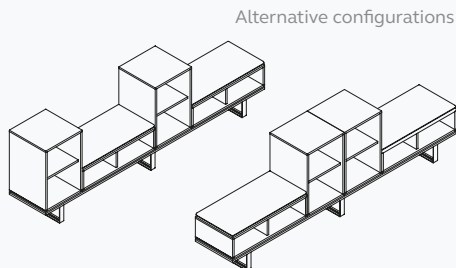
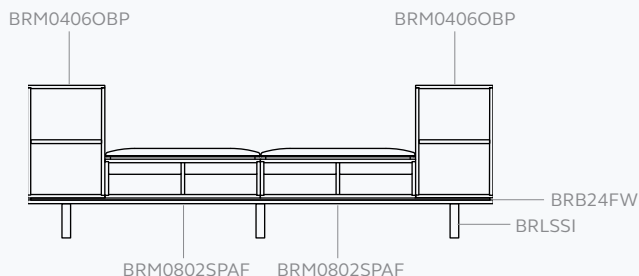

2400mm (94.5") wide, 400mm (15.7") deep

Code	Description	Width (mm)	Height (mm)
BRB24FW	Full width base	2400 (94.5")	30 (1.2")
BRLSSI	Steel skid leg (set of three)	132 (5.2")	175 (6.9")
BRM0406OBP	Shelf unit with one shelf	400 (15.7")	582 (23")
BRM0802SPAF	Seat unit with fabric seat pad (see page 31 for seat pad fabric options)	800 (31.5")	255 (10")
BRM0802SPAF	Seat unit with fabric seat pad (see page 31 for seat pad fabric options)	800 (31.5")	255 (10")
BRM0406OBP	Shelf unit with one shelf	400 (15.7")	582 (23")

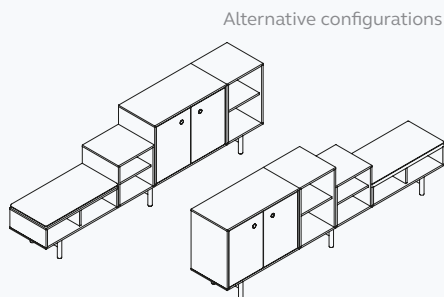
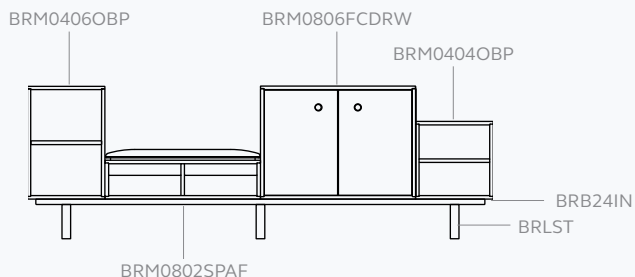

2400mm (94.5") wide, 400mm (15.7") deep

Code	Description	Width (mm)	Height (mm)
BRB24IN	Inset base	2312 (91")	26 (1")
BRLST	Steel tube leg (set of three)	35 (1.4")	175 (6.9")
BRM0406OBP	Shelf unit with one shelf	400 (15.7")	582 (23")
BRM0802SPAF	Seat unit with fabric seat pad (see page 31 for seat pad fabric options)	800 (31.5")	200 (7.9")
BRM0806FCDRW	Full double cupboard doors with round wood handles	800 (31.5")	582 (23")
BRM0404OBP	Shelf unit with one shelf	400 (15.7")	400 (15.7")

PLEASE NOTE to change handles, seat pad fabric, back panel finish or make top drawers lockable, please see pages 26-31 for alternative options and code swaps.

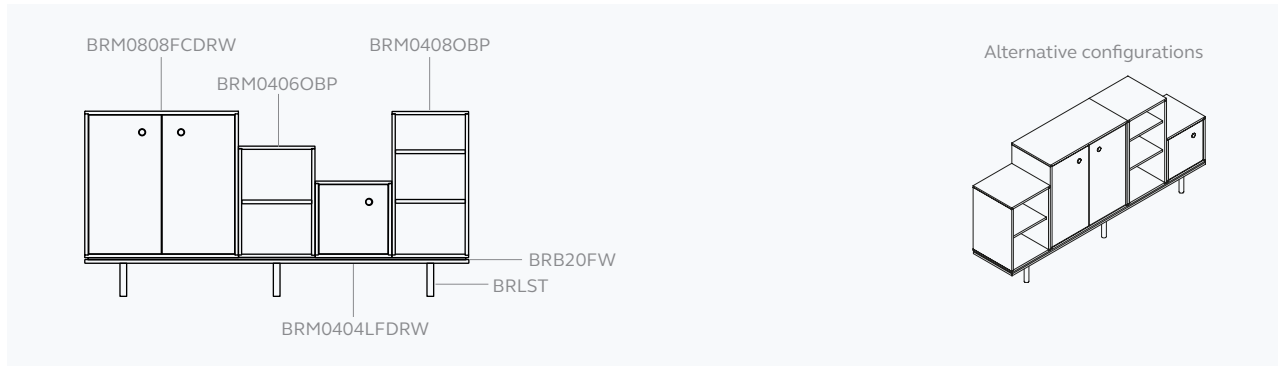

2000mm (78.7") wide, 400mm (15.7") deep

Code	Description	Width (mm)	Height (mm)
BRB20FW	Full width base	2000 (78.7")	30 (1.2")
BRLST	Steel tube leg (set of three)	35 (1.4")	175 (6.9")
BRM0808FCDRW	Full double cupboard doors with round wood handles	800 (31.5")	763 (30")
BRM0406OBP	Shelf unit with one shelf	400 (15.7")	582 (23")
BRM0404LFDRW	Full cupboard door, left hand open with round wood handle	400 (15.7")	400 (15.7")
BRM0408OBP	Shelf unit with two shelves	400 (15.7")	763 (30")

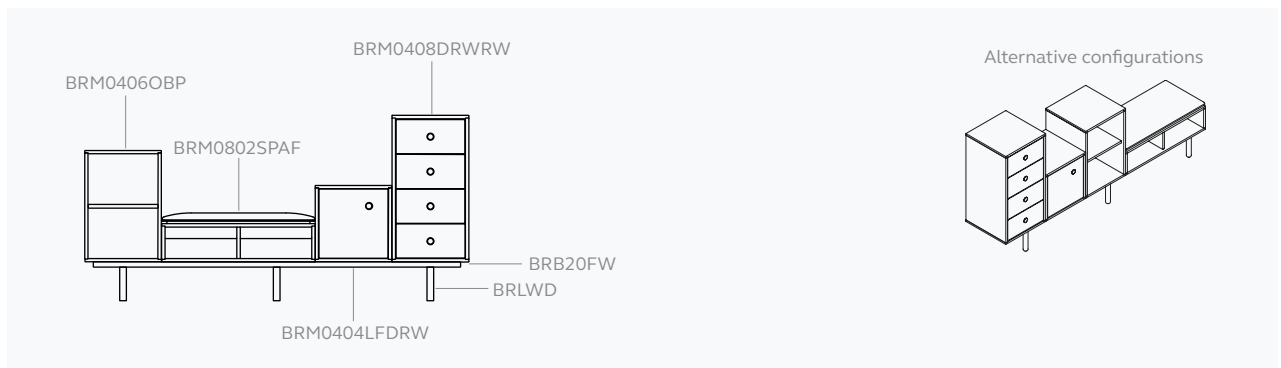

2000mm (78.7") wide, 400mm (15.7") deep

Code	Description	Width (mm)	Height (mm)
BRB20IN	Inset base	1912 (75.3")	30 (1.2")
BRLWD	Wooden dowel leg (set of three)	35 (1.4")	175 (6.9")
BRM0406OBP	Shelf unit with one shelf	400 (15.7")	582 (23")
BRM0802SPAF	Seat unit with fabric seat pad (see page 31 for seat pad fabric options)	800 (31.5")	255 (10")
BRM0404LFDRW	Full cupboard door, left hand open with round wood handle	400 (15.7")	400 (15.7")
BRM0408DRWRW	Unit with four 182mm drawers with round wood handles	400 (15.7")	763 (30")

Space Divider settings

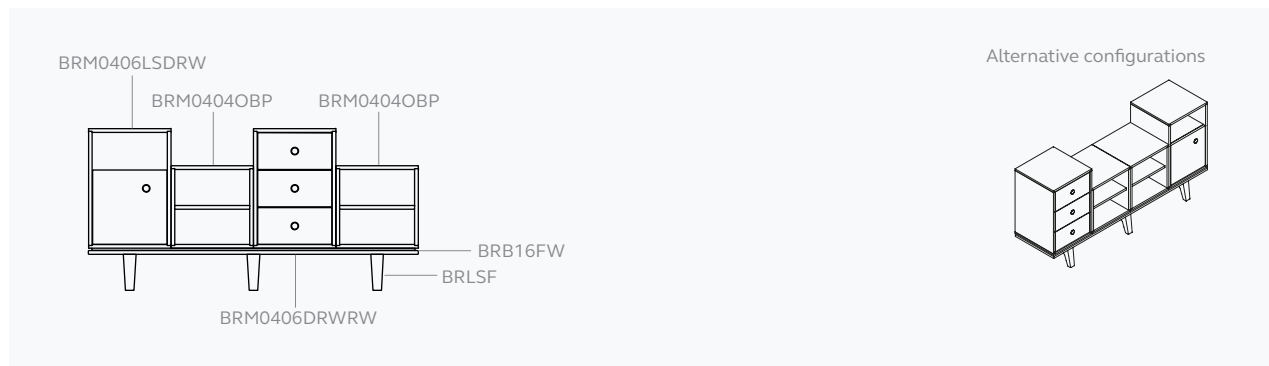

1600mm (63") wide, 400mm (15.7") deep

Code	Description	Width (mm)	Height (mm)
BRB16FW	Full width base	1600 (63")	30 (1.2")
BRLSF	Steel formed leg (set of three)	60 (2.4")	175 (6.9")
BRM0406LSDRW*	Three quarter cupboard door, left hand open with round wood handle	400 (15.7")	582 (23")
BRM0404OBP	Shelf unit with one shelf	400 (15.7")	400 (15.7")
BRM0406DRWRW	Unit with three 182mm drawers with round wood handles	400 (15.7")	582 (23")
BRM0404OBP	Shelf unit with one shelf	400 (15.7")	400 (15.7")

*Three quarter door compatible with BRSIB0402 steel box insert. See page 35.

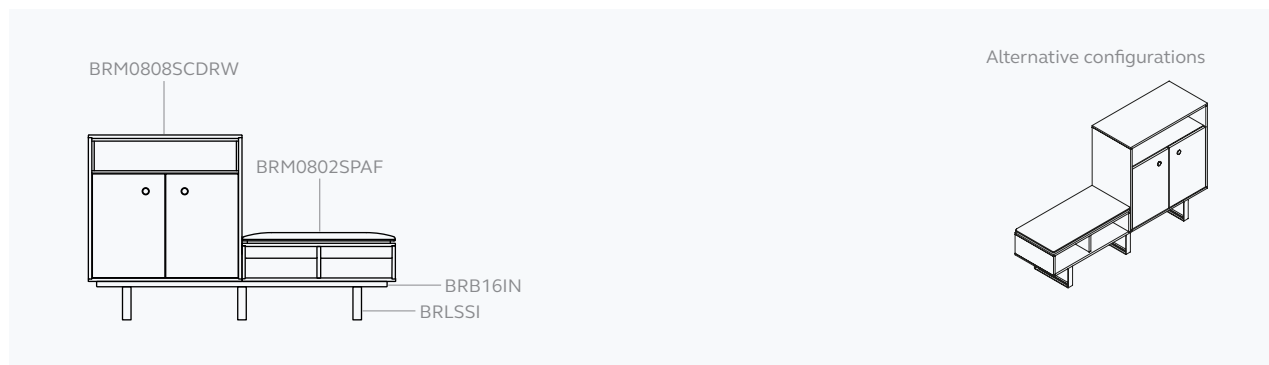

1600mm (63") wide, 400mm (15.7") deep

Code	Description	Width (mm)	Height (mm)
BRB16IN	Inset base	1512 (59.5")	30 (1.2")
BRLSSI	Steel skid inset leg (set of three)	132mm (5.2")	175mm (2.9")
BRM0808SCDRW*	Three quarter double cupboard doors with round wood handles	800 (31")	800 (31")
BRM0802SPAF	Seat unit with fabric seat pad (see page 31 for seat pad fabric options)	800 (31")	200 (7.9")

*Three quarter doors compatible with BRSIB0802 steel box insert. See page 35.

PLEASE NOTE to change handles, seat pad fabric, back panel finish or make top drawers lockable, please see pages 26-31 for alternative options and code swaps.

Choose any suggested Space Divider setting with the freedom to mix and match modules, finish options and accessories using the Create Your Own and Accessories sections on pages 26-35.

To order, you must specify finish options for each section of your Bridge unit. Please see pages 35-37 for more information.

Should you require any support with specifying a Bridge unit, please contact your Bisley Representative.



SKYLINE

A mixture of module heights mimic a city skyline. These settings are ideal for welcome areas and 'breakout zones'. The use of the seat pad unit provides a relaxing place to recharge or an impromptu place to perch throughout the working day.

Choose any suggested Skyline setting with the freedom to mix and match modules, finish options and accessories using the Create Your Own and Accessories sections on pages 26-35.





Skyline settings

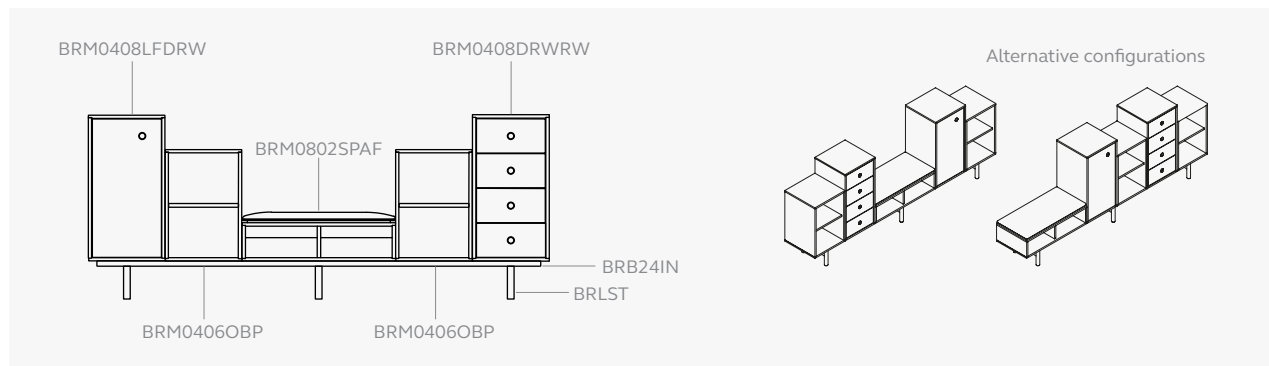

2400mm (94.5") wide, 400mm (15.7") deep

Code	Description	Width (mm)	Height (mm)
BRB24IN	Inset base	2312 (91")	26 (1")
BRLST	Steel tube leg (set of three)	35 (1.4")	175 (6.9")
BRM0408LFDRW	Full cupboard door, left hand open with round wood handle	400 (15.7")	763 (30")
BRM0406OBP	Shelf unit with one shelf	400 (15.7")	582 (23")
BRM0802SPAF	Seat unit with fabric seat pad (see page 31 for seat pad fabric options)	800 (31.5")	255 (10")
BRM0406OBP	Shelf unit with one shelf	400 (15.7")	582 (23")
BRM0408DRWRW	Unit with four 182mm drawers with round wood handles	400 (15.7")	763 (30")

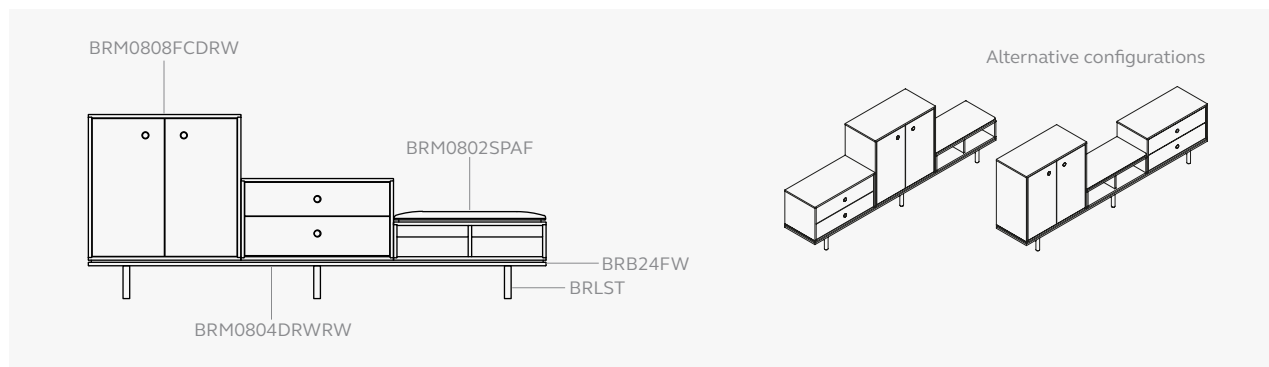

2400mm (94.5") wide, 400mm (15.7") deep

Code	Description	Width (mm)	Height (mm)
BRB24FW	Full width base	2400 (94.5")	30 (1.2")
BRLST	Steel tube leg (set of three)	35 (1.4")	175 (6.9")
BRM0808FCDRW	Full double cupboard doors with round wood handles	800 (31.5")	763 (30")
BRM0804DRWRW	Unit with two 182mm drawers with round wood handles	800 (31.5")	400 (15.7")
BRM0802SPAF	Seat unit with fabric seat pad (see page 31 for seat pad fabric options)	800 (31.5")	255 (10")

PLEASE NOTE to change handles, seat pad fabric, back panel finish or make top drawers lockable, please see pages 26-31 for alternative options and code swaps.

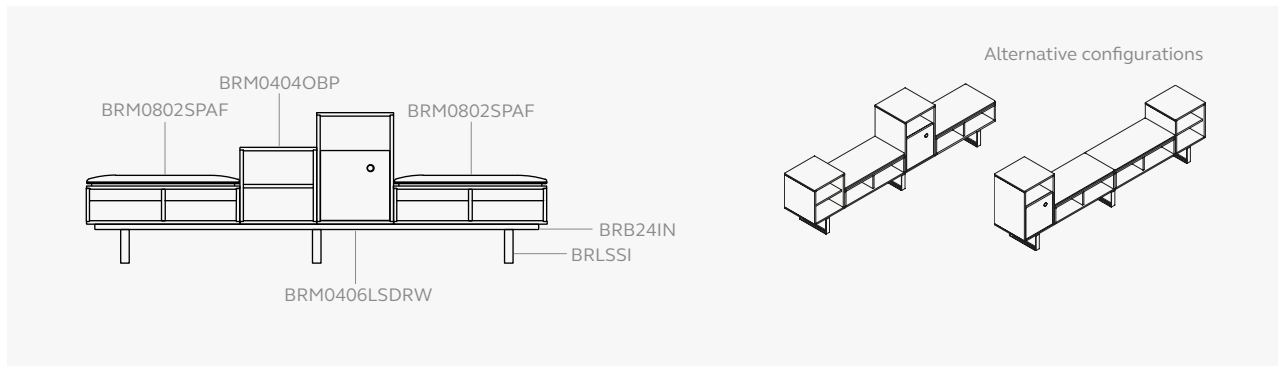

2400mm (94.5") wide, 400mm (15.7") deep

Code	Description	Width (mm)	Height (mm)
BRB24IN	Inset base	2312 (91")	26 (1")
BRLSSI	Steel skid leg (set of three)	132 (5.2")	175 (6.9")
BRM0802SPAF	Seat unit with fabric seat pad (see page 31 for seat pad fabric options)	800 (31.5")	255 (10")
BRM0404OBP	Shelf unit with one shelf	400 (15.7")	400 (15.7")
BRM0406LSDRW*	Three quarter cupboard door, left hand open with round wood handle	400 (15.7")	582 (23")
BRM0802SPAF	Seat unit with fabric seat pad (see page 31 for seat pad fabric options)	800 (31.5")	255 (10")

* Three quarter door compatible with BRSIB0402 steel box insert. See page 35.

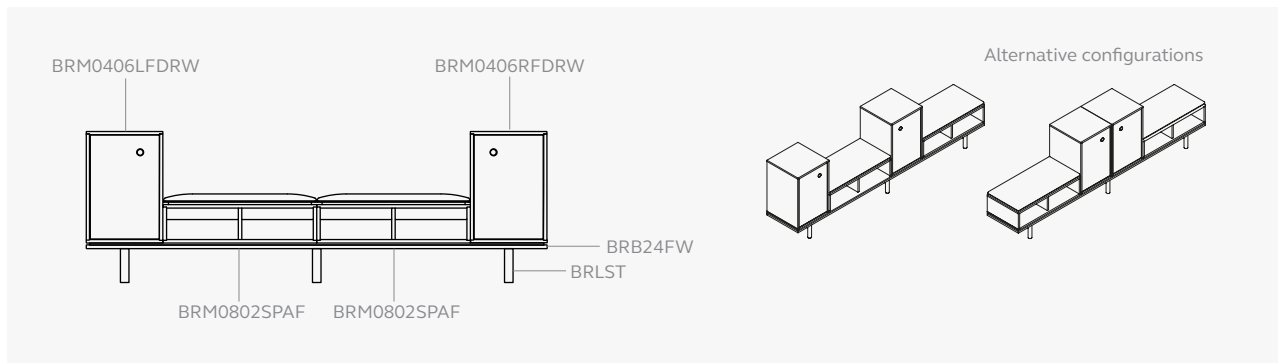

2400mm (94.5") wide, 400mm (15.7") deep

Code	Description	Width (mm)	Height (mm)
BRB24FW	Full width base	2400 (94.5")	30 (1.2")
BRLST	Steel tube leg (set of three)	44 (1.7")	175 (6.9")
BRM0406LFDRW	Full cupboard door, left hand open with round wood handle	400 (15.7")	582 (23")
BRM0802SPAF	Seat unit with fabric seat pad (see page 31 for seat pad fabric options)	800 (31.5")	255 (10")
BRM0802SPAF	Seat unit with fabric seat pad (see page 31 for seat pad fabric options)	800 (31.5")	255 (10")
BRM0406RFDRW	Full cupboard door, right hand open with round wood handle	400 (15.7")	582 (23")

Skyline settings

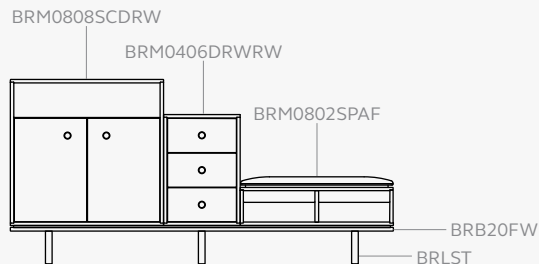

Alternative configurations

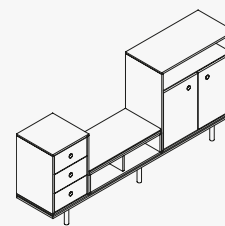

2000mm (78.7") wide, 400mm (15.7") deep

Code	Description	Width (mm)	Height (mm)
BRB20FW	Full width base	2000 (78.7")	30 (1.2")
BRLST	Steel tube leg (set of three)	35 (1.4")	175 (6.9")
BRM0808SCDRW*	Three quarter double cupboard doors with round wood handles	800 (31.5")	763 (30")
BRM0406DRWRW	Unit with three 182mm drawers with round wood handles	400 (15.7")	582 (23")
BRM0802SPAF	Seat unit with fabric seat pad (see page 31 for seat pad fabric options)	800 (31.5")	255 (10")

* Three quarter door compatible with BRSIB0402 steel box insert. See page 35.

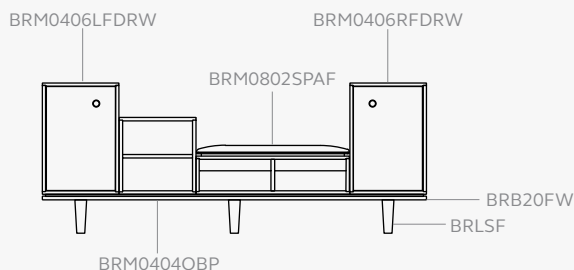

Alternative configurations

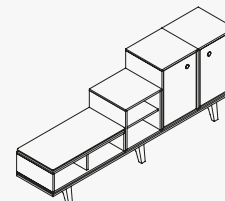

2000mm (78.7") wide, 400mm (15.7") deep

Code	Description	Width (mm)	Height (mm)
BRB20FW	Full width base	2000 (78.7")	30 (1.2")
BRLSF	Steel formed leg (set of three)	60 (2.4")	175 (6.9")
BRM0406LFDRW	Full cupboard door, left hand open with round wood handle	400 (15.7")	582 (23")
BRM0404OBP	Shelf unit with one shelf	400 (15.7")	400 (15.7")
BRM0802SPAF	Seat unit with fabric seat pad (see page 31 for seat pad fabric options)	800 (31.5")	255 (10")
BRM0406RFDRW	Full cupboard door, right hand open with round wood handle	400 (15.7")	582 (23")

PLEASE NOTE to change handles, seat pad fabric, back panel finish or make top drawers lockable, please see pages 26-31 for alternative options and code swaps.

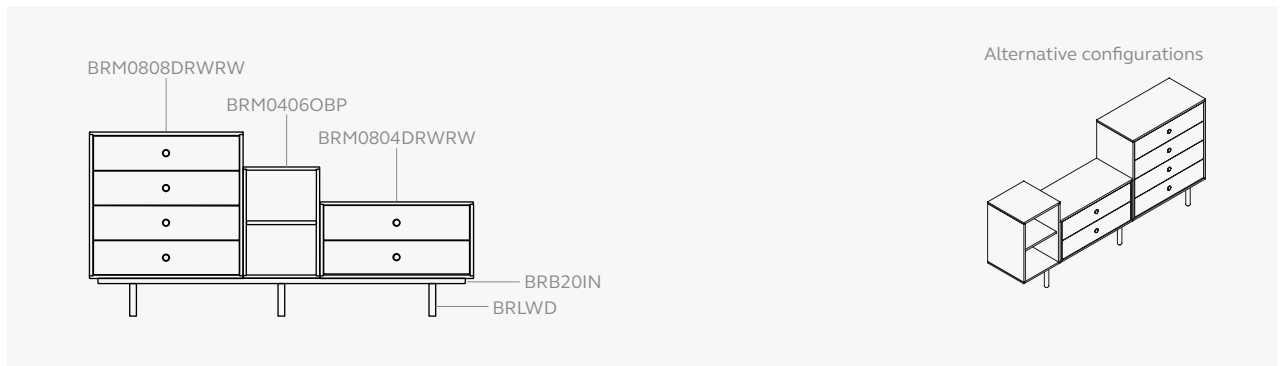

2000mm (78.7") wide, 400mm (15.7") deep

Code	Description	Width (mm)	Height (mm)
BRB20IN	Inset base	1912 (75.3")	26 (1")
BRLWD	Wooden dowel leg (set of three)	35 (1.4")	175 (6.9")
BRM0808DRWRW	Unit with four 182mm drawers with round wood handles	800 (31.5")	763 (30")
BRM0406OBP	Shelf unit with one shelf	400 (15.7")	582 (23")
BRM0804DRWRW	Unit with two 182mm drawers with round wood handles	800 (31.5")	400 (15.7")

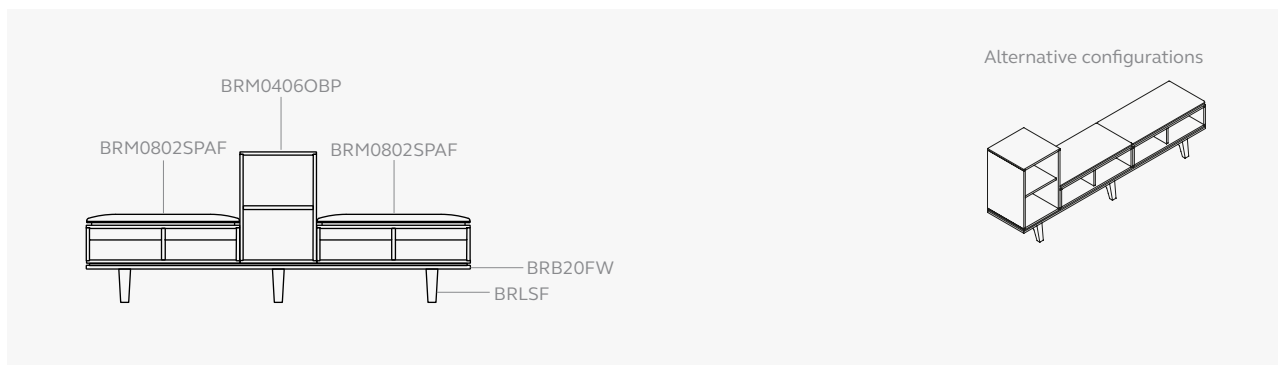

2000mm (78.7") wide, 400mm (15.7") deep

Code	Description	Width (mm)	Height (mm)
BRB20FW	Full width base	2000 (78.7")	26 (1")
BRLSF	Steel formed leg (set of three)	60 (2.4")	175 (6.9")
BRM0802SPAF	Seat unit with fabric seat pad (see page 31 for seat pad fabric options)	800 (31.5")	200 (7.9")
BRM0406OBP	Shelf unit with one shelf	400 (15.7")	582 (23")
BRM0802SPAF	Seat unit with fabric seat pad (see page 31 for seat pad fabric options)	800 (31.5")	255 (10")

Skyline settings

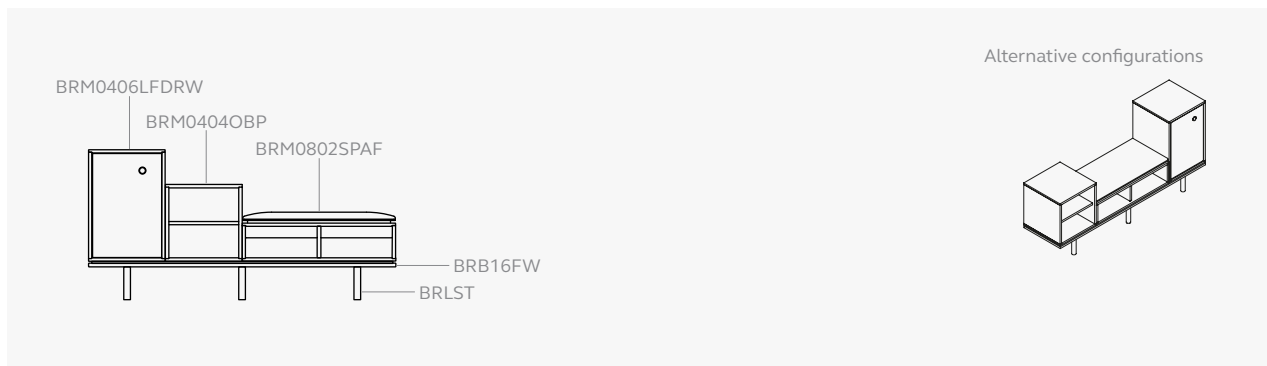

1600mm (63") wide, 400mm (15.7") deep

Code	Description	Width (mm)	Height (mm)
BRB16FW	Full width base	1600 (63")	30 (1.2")
BRLST	Steel tube leg (set of three)	35 (1.4")	172 (6.8")
BRM0406LFDRW	Full cupboard door, left hand open with round wood handle	400 (15.7")	582 (23")
BRM0404OBP	Shelf unit with one shelf	400 (15.7")	400 (15.7")
BRM0802SPAF	Seat unit with fabric seat pad (see page 31 for seat pad fabric options)	800 (31.5")	255 (10")

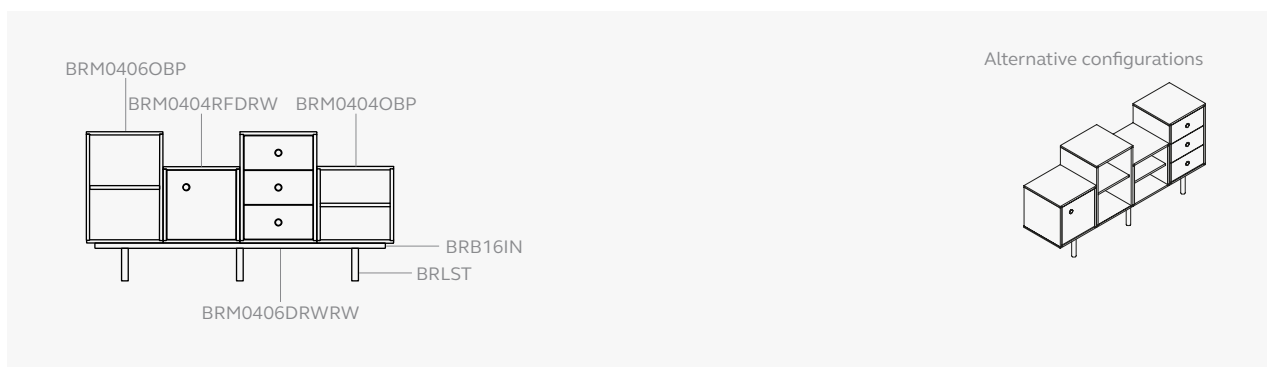

1600mm (63") wide, 400mm (15.7") deep

Code	Description	Width (mm)	Height (mm)
BRB16IN	Inset base	1512 (59.5")	30 (1.2")
BRLST	Steel tube leg (set of three)	35 (1.4")	172 (6.8")
BRM0406OBP	Shelf unit with one shelf	400 (15.7")	582 (23")
BRM0404RFDRW	Full cupboard door, right hand open with round wood handle	400 (15.7")	400 (15.7")
BRM0406DRWRW	Unit with three 182mm drawers with round wood handles	400 (15.7")	582 (23")
BRM0404OBP	Shelf unit with one shelf	400 (15.7")	400 (15.7")

PLEASE NOTE to change handles, seat pad fabric, back panel finish or make top drawers lockable, please see pages 26-31 for alternative options and code swaps.

Choose any suggested Skyline setting with the freedom to mix and match modules, finish options and accessories using the Create Your Own and Accessories sections on pages 26-35.

To order, you must specify finish options for each section of your Bridge unit. Please see pages 35-37 for more information.

Should you require any support with specifying a Bridge unit, please contact your Bisley Representative.



MEETING ROOM CREDENZA

Inspired by the traditional meeting room credenza, but re-imagined for the contemporary office and work styles, these suggested settings mimic the classic single height credenza, with the versatility to create a professional or playful addition to the meeting space.

Choose any Space Divider setting with the freedom to mix and match modules, finish options and accessories using the Create Your Own and Accessories sections on pages 26-35.



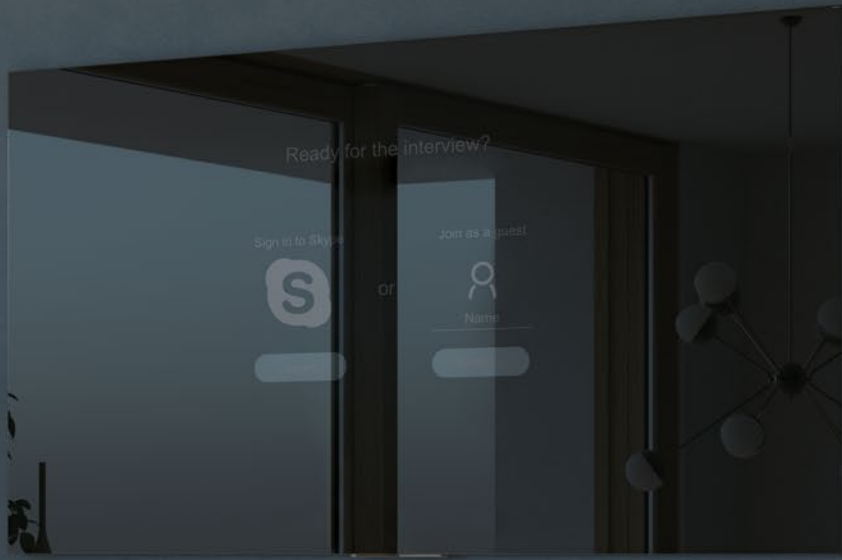

Meeting Room Credenza settings

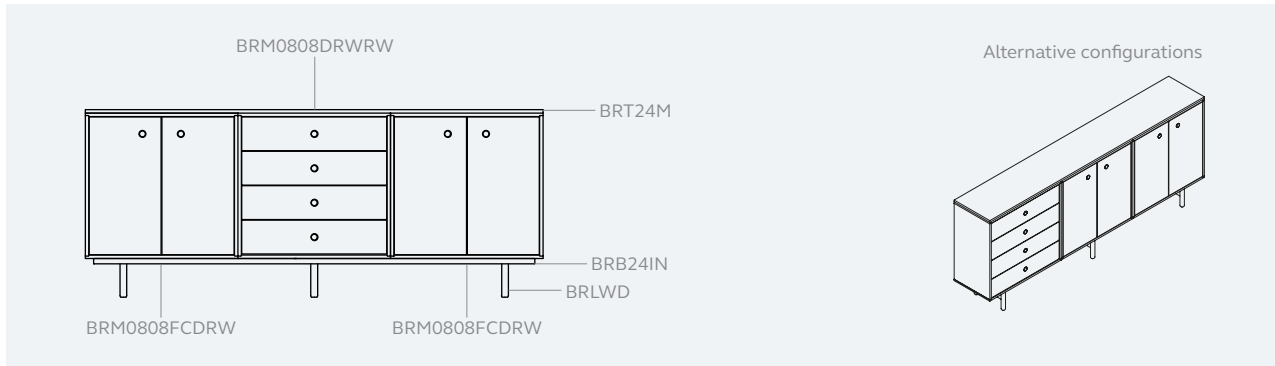

2400mm (94.5") wide, 400mm (15.7") deep

Code	Description	Width (mm)	Height (mm)
BRB24IN	Inset base	2312 (91")	26 (1")
BRLWD	Wooden dowel leg (set of three)	35 (1.4")	175 (6.9")
BRT24M	Decorative top (MFC)	2400 (94.5")	18 (0.7")
BRM0808FCDRW	Full double cupboard doors with round wood handles	800 (31.5")	763 (30")
BRM0808DRRWW	Unit with four 182mm drawers with round wood handles	800 (31.5")	763 (30")
BRM0808FCDRW	Full double cupboard doors with round wood handles	800 (31.5")	763 (30")

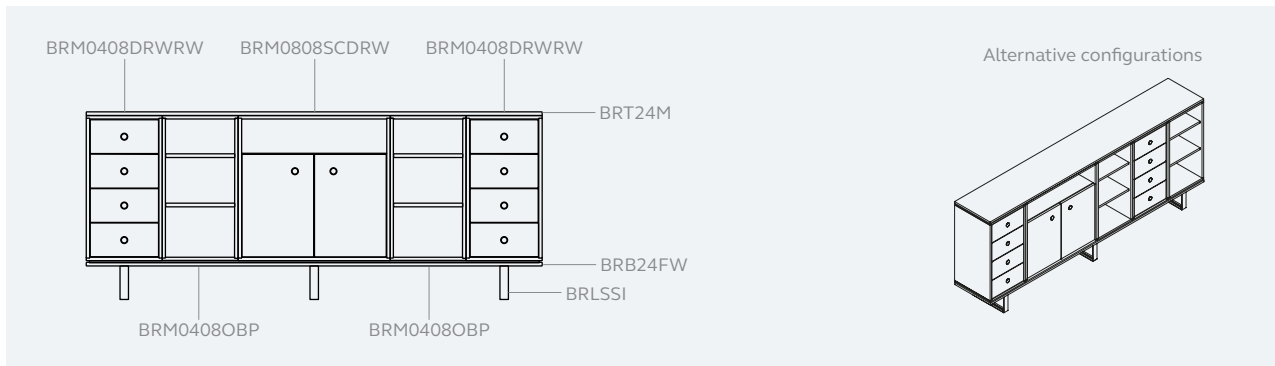

2400mm (94.5") wide, 400mm (15.7") deep

Code	Description	Width (mm)	Height (mm)
BRB24FW	Full width base	2400 (94.5")	30 (1.2")
BRLSSI	Steel skid leg (set of three)	44 (1.7")	175 (6.9")
BRT24M	Decorative top (MFC)	2400 (94.5")	18 (0.7")
BRM0408DRRWW	Unit with four 182mm drawers with round wood handles	400 (15.7")	763 (30")
BRM0408OBP	Shelf unit with two shelves	400 (15.7")	763 (30")
BRM0808SCDRW*	Three quarter double cupboard doors with round wood handles	800 (31.5")	763 (30")
BRM0408OBP	Shelf unit with two shelves	400 (15.7")	763 (30")
BRM0408DRRWW	Unit with four 182mm drawers with round wood handles	400 (15.7")	763 (30")

* Three quarter doors compatible with BRSIB0802 steel box insert. See page 35.

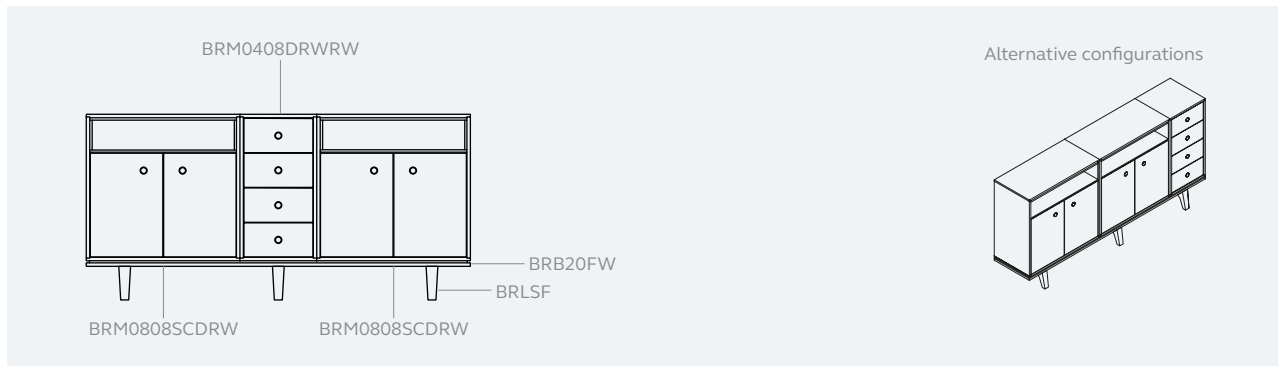

2000mm (78.7") wide, 400mm (15.7") deep

Code	Description	Width (mm)	Height (mm)
BRB20FW	Full width base	2000 (78.7")	30 (1.2")
BRLSF	Steel formed leg (set of three)	60 (2.4")	175 (6.9")
BRM0808SCDRW*	Three quarter double cupboard doors with round wood handles	800 (31.5")	763 (30")
BRM0408DRWRW	Unit with four 182mm drawers with round wood handles	400 (15.7")	763 (30")
BRM0808SCDRW*	Three quarter double cupboard doors with round wood handles	800 (31.5")	763 (30")

* Three quarter door compatible with BRSIB0802 steel box insert. See page 35.

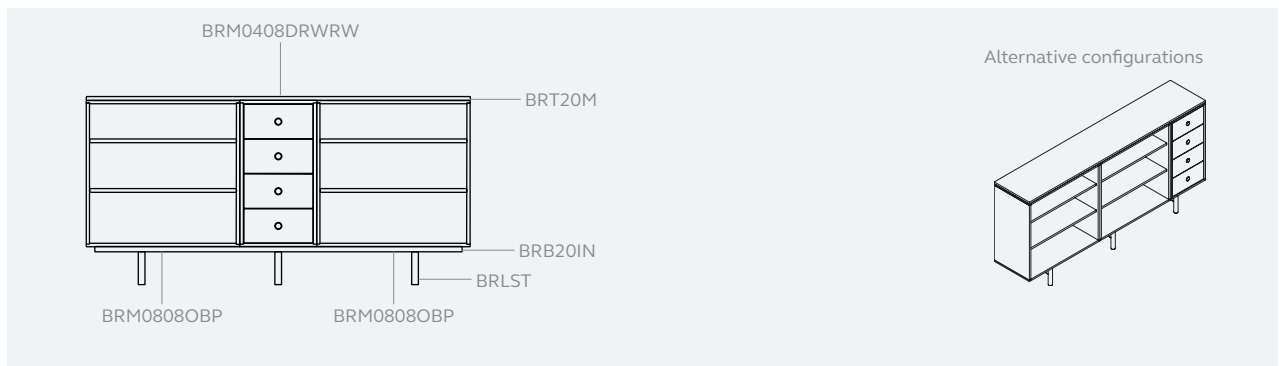

2000mm (78.7") wide, 400mm (15.7") deep

Code	Description	Width (mm)	Height (mm)
BRB20IN	Inset base	1912 (75.3")	26 (1")
BRLST	Steel tube leg (set of three)	35 (1.4")	175 (6.9")
BRT20M	Decorative top (MFC)	2000 (78.7")	18 (0.7")
BRM0808OBP	Shelf unit with two shelves	400 (15.7")	763 (30")
BRM0408DRWRW	Unit with four 182mm drawers with round wood handles	800 (31.5")	763 (30")
BRM0808OBP	Shelf unit with two shelves	400 (15.7")	763 (30")

PLEASE NOTE to change handles, back panel finish or make top drawers lockable, please see pages 26-35 for alternative options and code swaps.

Meeting Room Credenza settings

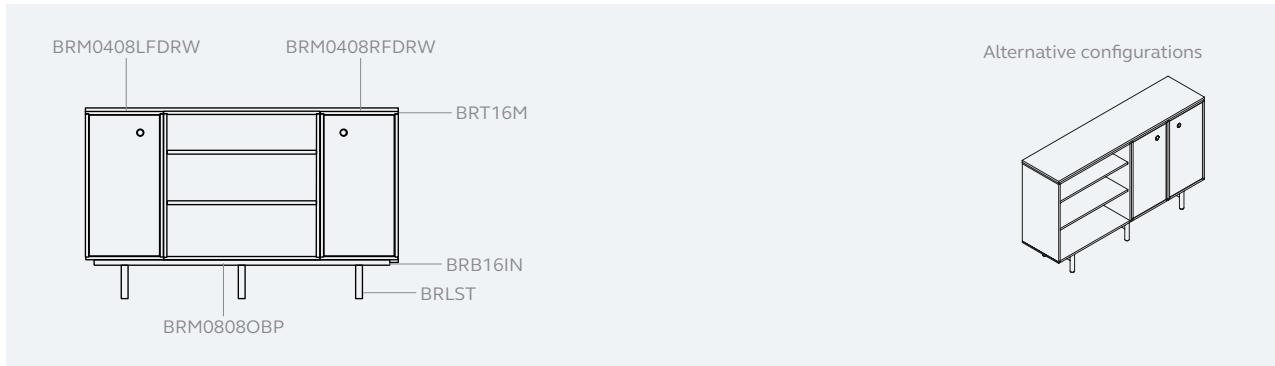

1600mm (63") wide, 400mm (15.7") deep

Code	Description	Width (mm)	Height (mm)
BRB16IN	Inset base	1512 (59.5")	26 (1")
BRLST	Steel tube leg (set of three)	35 (1.4")	175 (6.9")
BRT16M	Decorative top (MFC)	1600 (63")	18 (0.7")
BRM0408LFDRW	Full cupboard door, left hand open with round wood handle	400 (15.7")	763 (30")
BRM0808OBP	Shelf unit with two shelves	800 (31.5")	763 (30")
BRM0408RFDRW	Full cupboard door, right hand open with round wood handle	400 (15.7")	763 (30")

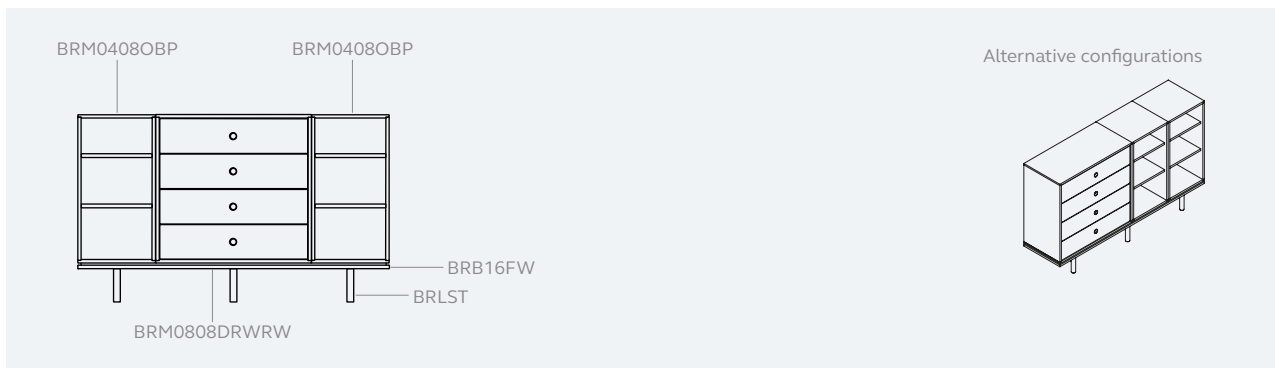

1600mm (63") wide, 400mm (15.7") deep

Code	Description	Width (mm)	Height (mm)
BRB16FW	Full width base	1600 (63")	26 (1")
BRLST	Steel tube leg (set of three)	35 (1.4")	175 (6.9")
BRM0408OBP	Shelf unit with two shelves	400 (15.7")	763 (30")
BRM0808DRWRW	Unit with four 182mm drawers with round wood handles	800 (31.5")	763 (30")
BRM0408OBP	Shelf unit with two shelves	400 (15.7")	763 (30")

PLEASE NOTE to change handles, back panel finish or make top drawers lockable, please see pages 26-31 for alternative options and code swaps.

Choose any suggested Meeting Room Credenza setting with the freedom to mix and match modules, finish options and accessories using the Create Your Own and Accessories sections on pages 26-35.

To order, you must specify finish options for each section of your Bridge unit. Please see pages 35-37 for more information.

Should you require any support with specifying a Bridge unit, please contact your Bisley Representative.



CREATE YOUR OWN

Bridge is entirely customisable; our vibrant range of storage and display modules, colours, finishes and creative back panels will inject colour, texture and warmth to your environment – the fun is in creating exactly what you imagined!

Once you have chosen all of your Bridge elements from the following pages, you must then specify a finish for each module. Please see pages 36-37 for finish options.



BASES
See page 28.

LEGS
See page 28.

CUPBOARDS
See page 29.

SEAT UNIT
See page 31.

DRAWERS
See page 30.



BASES

Choose from three base sizes

LEGS

Choose from three steel leg options and one wooden leg option

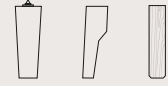

CUPBOARDS

Choose from fifteen cupboard modules

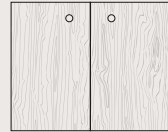

DRAWERS

Choose from six drawer modules with the option to make the top drawer lockable



SHELVES

Choose from six shelf modules

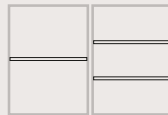

SEAT UNIT

Fabric and leather seat pad finishes available



ACCESSORIES

Add decorative steel box inserts, decorative wooden tops and planter tops to your Bridge unit



ACCESSORIES

Add decorative steel box inserts, decorative tops or planter tops. See pages 32-35 for all accessories.

SHELVES

See page 31.

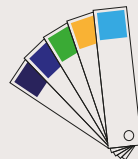

NEXT STEP

You must specify finish options for each module where applicable. See pages 35-37 for all handle, paint, wood and fabric finish options.

Bases

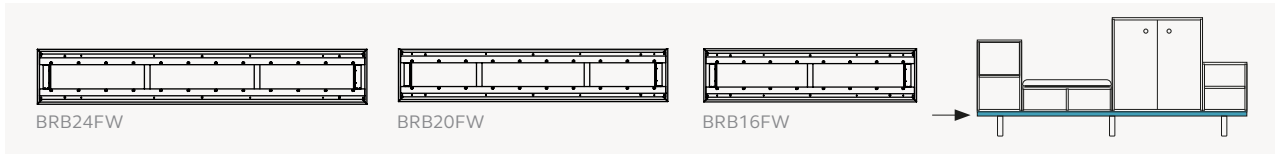

Full width base options, 400mm (15.7") deep

Code	Description	Width (mm)
BRB24FW	2400mm full width base	2400 (94.5")
BRB24FWCM	2400mm full width base with cable management	2400 (94.5")
BRB20FW	2000mm full width base	2000 (78.7")
BRB20FWCM	2000mm full width base with cable management	2000 (78.7")
BRB16FW	1600mm full width base	1600 (63")
BRB16FWCM	1600mm full width base with cable management	1600 (63")

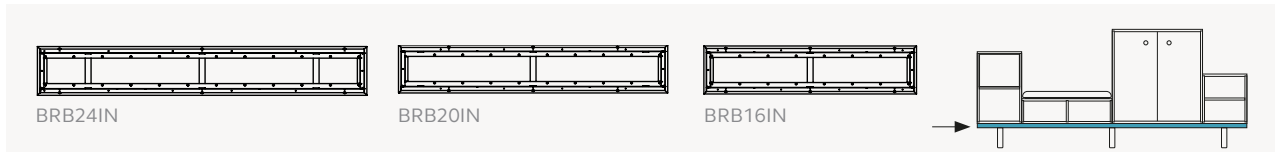

Inset base options, 342mm (13.5") deep

Code	Description	Width (mm)
BRB24IN	2400mm inset base	2312 (91")
BRB24INCM	2400mm inset base with cable management	2312 (91")
BRB20IN	2000mm inset base	1912 (75.3")
BRB20INCM	2000mm inset base with cable management	1912 (75.3")
BRB16IN	1600mm inset base	1512 (59.5")
BRB16INCM	1600mm inset base with cable management	1512 (59.5")

Legs

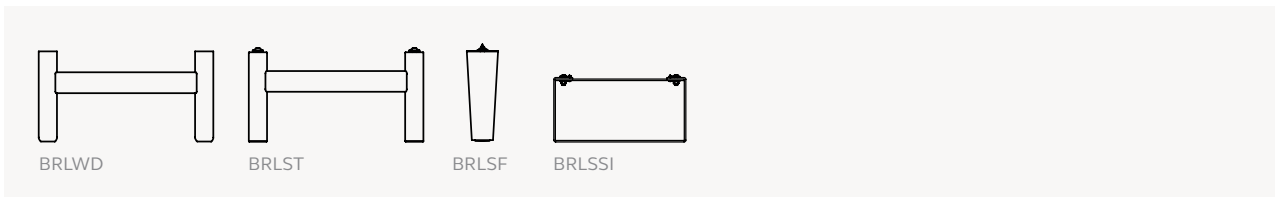

Code	Description	Width (mm)	Height (mm)
BRLWD	Wooden dowel leg (set of three)	105 (4.1")	175 (2.9")
BRLST	Steel tube leg (set of three)	105 (4.1")	175 (2.9")
BRLSF	Steel formed leg (set of three)	366 (14.4")	175 (2.9")
BRLSSI	Steel skid leg (set of three)	132 (5.2")	175 (2.9")

Cupboard modules

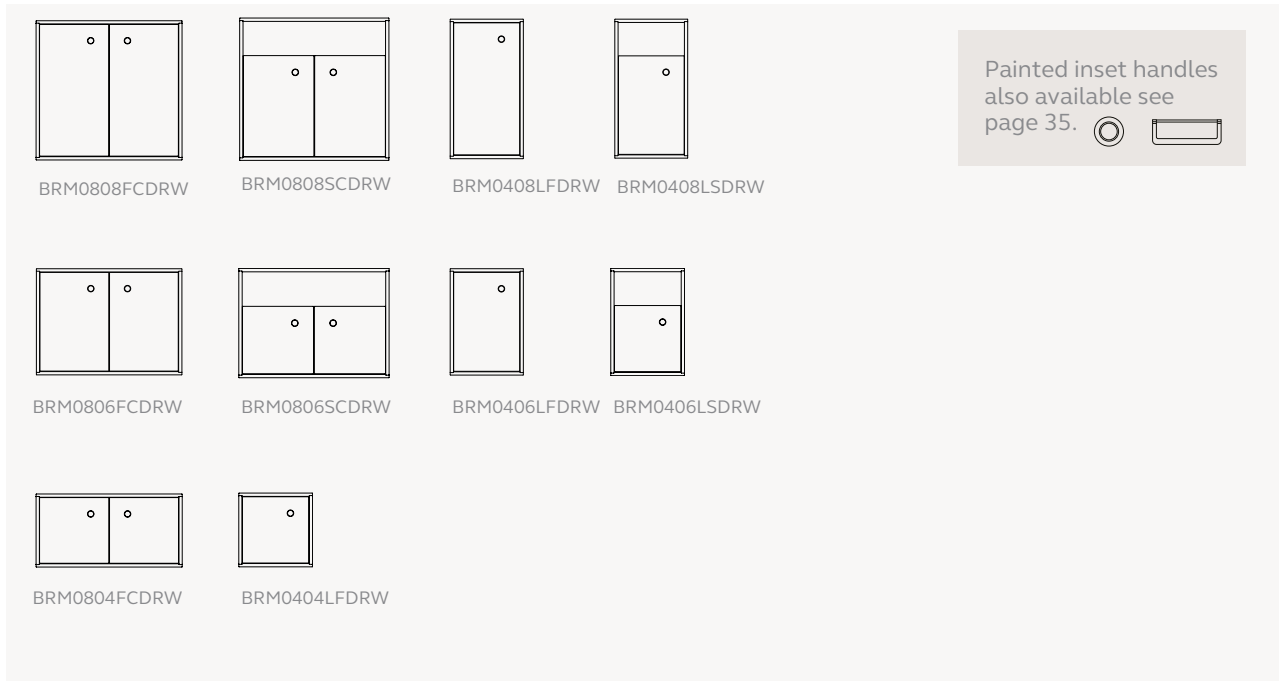

400mm (15.7") deep

Code (with wood or steel back panels)	Code (with fabric back panels)	Description	Width (mm)	Height (mm)
BRM0808FCD*	BRM0808FCDF*†	Full double cupboard doors	800 (31.5")	763 (30")
BRM0808SCD*	BRM0808SCDF*†	Three quarter double cupboard doors*	800 (31.5")	763 (30")
BRM0806FCD*	BRM0806FCDF*†	Full double cupboard doors	800 (31.5")	582 (23")
BRM0806SCD*	BRM0806SCDF*†	Three quarter double cupboard doors*	800 (31.5")	582 (23")
BRM0804FCD*	BRM0804FCDF*†	Full double cupboard doors	800 (31.5")	400 (15.7")
BRM0408RFD*	BRM0408RFDF*†	Full cupboard door, right hand open	400 (15.7")	763 (30")
BRM0408LFD*	BRM0408LFDF*†	Full cupboard door, left hand open	400 (15.7")	763 (30")
BRM0408RSD*	BRM0408RSDF*†	Three quarter cupboard door, right hand open*	400 (15.7")	763 (30")
BRM0408LSD*	BRM0408LSDF*†	Three quarter cupboard door, left hand open*	400 (15.7")	763 (30")
BRM0406RFD*	BRM0406RFDF*†	Full cupboard door, right hand open	400 (15.7")	582 (23")
BRM0406LFD*	BRM0406LFDF*†	Full cupboard door, left hand open	400 (15.7")	582 (23")
BRM0406RSD*	BRM0406RSDF*†	Three quarter cupboard door, right hand open*	400 (15.7")	582 (23")
BRM0406LSD*	BRM0406LSDF*†	Three quarter cupboard door, left hand open*	400 (15.7")	582 (23")
BRM0404RFD	BRM0404RFDF*†	Full cupboard door, right hand open	400 (15.7")	400 (15.7")
BRM0404LFD*	BRM0404LFDF*†	Full cupboard door, left hand open	400 (15.7")	400 (15.7")

*For a round wood handle, add 'RW' to the end of the codes above. For a painted inset handle, add 'BS' to the end of the codes above. (For handle options, see page 35).

† For fabric options, please see pages 36-37.

Drawer modules

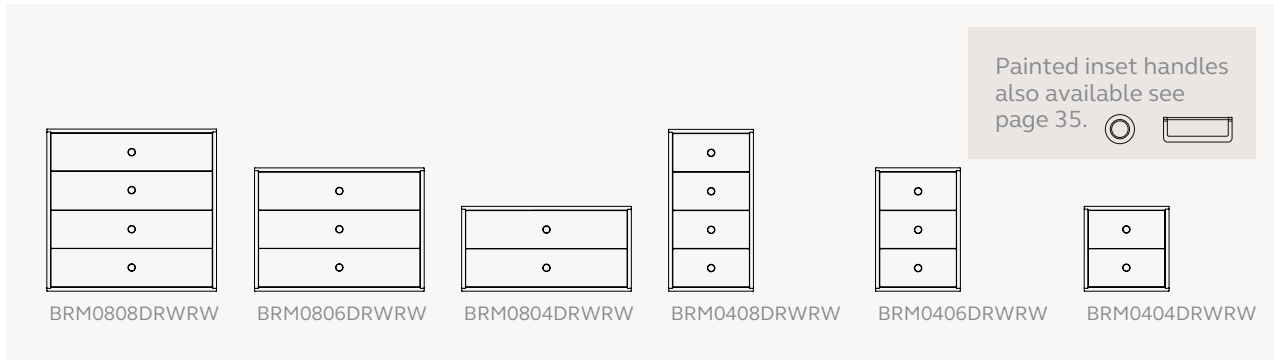

Code (with wood or steel back panels)	Code (with fabric back panels)	Description	Width (mm)	Height (mm)
BRM0808DRW*	BRM0808DRWF*†	Unit with four 182mm drawers	800 (31.5")	763 (30")
BRM0808DRL*	BRM0808DRLF*†	Unit with four 182mm drawers and lockable top drawer (AB key lock)	800 (31.5")	763 (30")
BRM0806DRW*	BRM0806DRWF*†	Unit with three 182mm drawers	800 (31.5")	582 (23")
BRM0806DRL*	BRM0806DRLF*†	Unit with three 182mm drawers and lockable top drawer (AB key lock)	800 (31.5")	582 (23")
BRM0804DRW*	BRM0804DRWF*†	Unit with two x 182mm drawers	800 (31.5")	400 (15.7")
BRM0804DRL*	BRM0804DRLF*†	Unit with two 182mm drawers and lockable top drawer (AB key lock)	800 (31.5")	400 (15.7")
BRM0408DRW*	BRM0408DRWF*†	Unit with four 182mm drawers	400 (15.7")	763 (30")
BRM0408DRL*	BRM0408DRLF*†	Unit with four 182mm drawers and lockable top drawer (AB key lock)	400 (15.7")	763 (30")
BRM0406DRW*	BRM0406DRWF*†	Unit with three 182mm drawers	400 (15.7")	582 (23")
BRM0406DRL*	BRM0406DRLF*†	Unit with three 182mm drawers and lockable top drawer (AB key lock)	400 (15.7")	582 (23")
BRM0404DRW*	BRM0404DRWF*†	Unit with two 182mm drawers	400 (15.7")	400 (15.7")
BRM0404DRL*	BRM0404DRLF*†	Unit with two 182mm drawers and lockable top drawer (AB key lock)	400 (15.7")	400 (15.7")

*For a round wood handle, add 'RW' to the end of the codes above. For a painted inset handle, add 'BS' to the end of the codes above. (For handle options, see page 35).

† For fabric options, please see pages 36-37.

Shelf modules

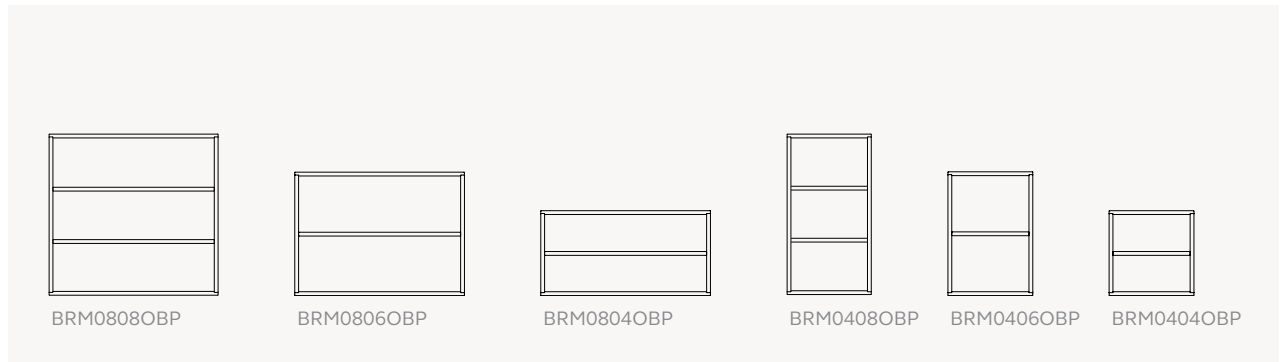

Code (with wood or steel back panels)	Code (with fabric back panels)	Description	Width (mm)	Height (mm)
BRM0808OBP	BRM0808OBPF*	Shelf unit with two shelves	800 (31.5")	763 (30")
BRM0806OBP	BRM0806OBPF*	Shelf unit with one shelf	800 (31.5")	582 (23")
BRM0804OBP	BRM0804OBPF*	Shelf unit with one shelf	800 (31.5")	400 (15.7")
BRM0408OBP	BRM0408OBPF*	Shelf unit with two shelves	400 (15.7")	763 (30")
BRM0406OBP	BRM0406OBPF*	Shelf unit with one shelf	400 (15.7")	582 (23")
BRM0404OBP	BRM0404OBPF*	Shelf unit with one shelf	400 (15.7")	400 (15.7")

*For fabric options, please see pages 36-37.

Seat units

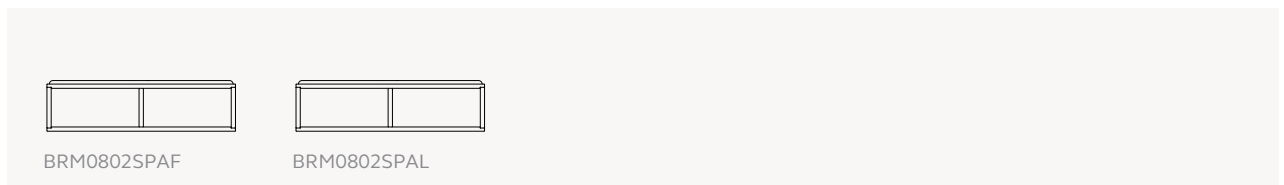

Code	Description	Width (mm)	Height (mm)
BRM0802SPAF	Seat unit with fabric seat pad	800 (31.5")	255 (10")
BRM0802SPAL	Seat unit with leather seat pad	800 (31.5")	255 (10")

See pages 36-37 for fabric and leather finish options.

ACCESSORIES

Complete your Bridge configuration with a range of accessories to support your working day. The addition of planter tops support a healthier working environment and decorative tops create a flush finish on a bank of modules. Add painted steel box inserts to inject layers of colour to your Bridge and allow extra division of open shelves.



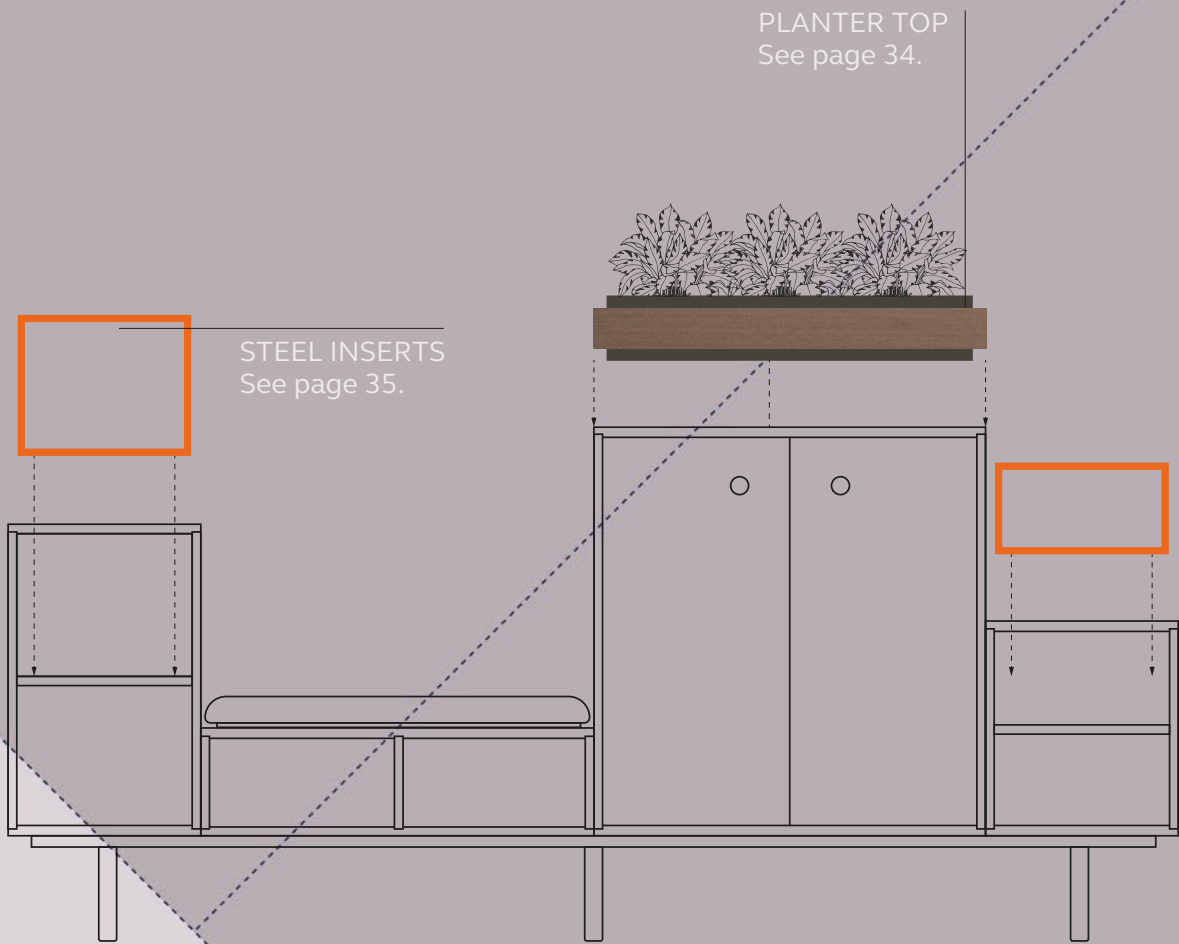

PLANTER TOP
See page 34.

STEEL INSERTS
See page 35.

Decorative tops

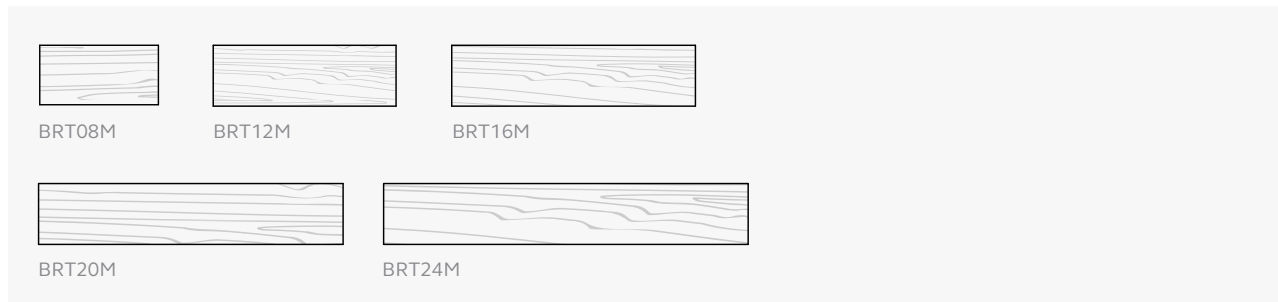

Code	Description	Width (mm)	Height (mm)
BRT08M	18mm decorative top	800 (31.5")	18 (0.7")
BRT12M	18mm decorative top	1200 (47.2")	18 (0.7")
BRT16M	18mm decorative top	1600 (63")	18 (0.7")
BRT20M	18mm decorative top	2000 (78.7")	18 (0.7")
BRT24M	18mm decorative top	2400 (94.5")	18 (0.7")

Planter tops

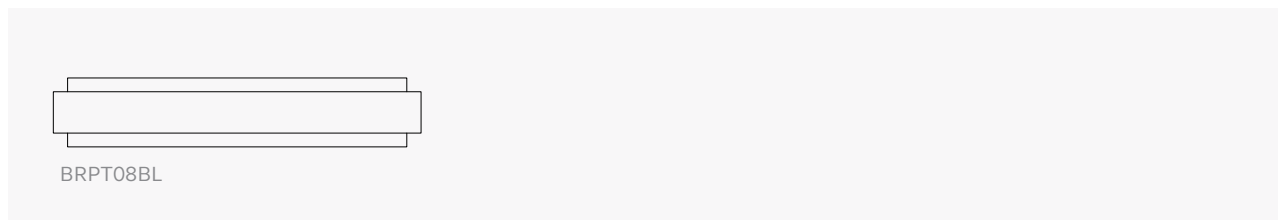

Code	Description	Width (mm)	Height (mm)
BRPT08BL	Planter top accessory	800 (31.5")	80 (3.1")

*For planter finish options, please see pages 36-37).

Cable Management Pack

To be retro-fitted to existing base

Code	Description	Width (mm)	Height (mm)
BRB24CM	Cable management pack	-	-
BRB20CM	Cable management pack	-	-
BRB16CM	Cable management pack	-	-

Steel box inserts



Code	Description	Width (mm)	Height (mm)
BRSIB0802	Steel box insert	800 (31")	200 (7.9")
BRSIB0402	Steel box insert	400 (16")	200 (7.9")
BRSIB0404	Steel box insert	400 (16")	400 (16")

FINISH OPTIONS

Handles

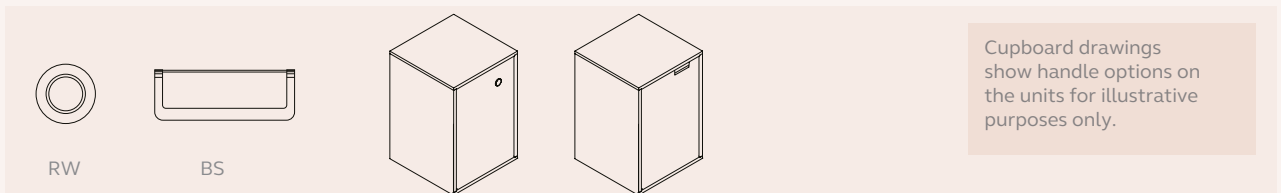

Cupboard drawings show handle options on the units for illustrative purposes only.

Suffix code with...	Description
RW	Round wood handle
BS	Painted inset handle

FINISH OPTIONS

All items within the Bridge range require you to select a finish option for each element:

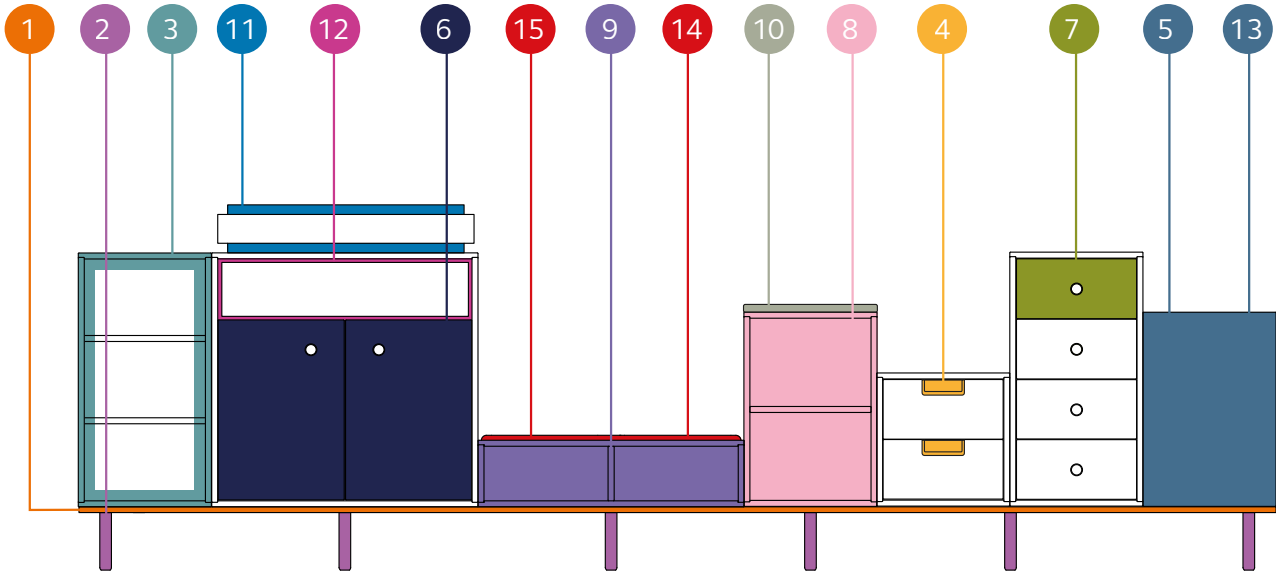

1. **Base** – select from 33 paint colours from the Vision colour palette.
2. **Legs** – select from 4 leg options (see page 28 for options).
Steel legs – select from 33 paint colours from the Vision colour palette – steel leg finish must match base finish.
Wooden dowell leg – select from 3 wood finishes (Dark 808, Medium 807, Light 847).
3. **Carcase finish** – you must specify a carcase finish for all modules (cupboards, drawers, shelves and seat units). Select from 7 laminate finishes.
 Please note you must select the same laminate for all module carcasses on the same base.

4. **Handle type and finish** – all cupboards and drawers require a handle choice and finish to be specified. Select from 2 handle options (see page 35 for options) Round Wood Handle (RW) Select from 3 wood finishes Dark 808, Medium 807, Light 847 Painted Inset Handle (BS) Select from 33 paint colours from the Vision colour palette.
 Please note all handles on the same base must be the same type and finish, except for the handle finish on top drawers which can be different if required.
5. **Back panels** – all cupboards, drawers and shelves require a back panel finish to be specified. Select from 33 paint colours from the Vision colour palette, 7 laminate finishes or over 100 fabric options (see step 13).

Steel Colours

Code	Colour Name
AB9	Chalk
AV8	Beige
AV6	Cream
BP2	Bisley Yellow
CD1	Sunflower Yellow
BQ6	Tickleweed
BH2	Bisley Green
BX6	Olive Green
BQ5	Dijon
AV5	Coffee
BR8	Sepia Brown
BQ4	Seville
AY8	Cardinal Red
BN6	Bisley Orange
BE2	Fuchsia
CB2	Palest Pink
BR4	Bisley Pink

Code	Colour Name
BC6	Bisley Blue
BP5	Azure
AN7	Doulton
BZ2	Ocean Blue
AY7	Oxford Blue
BP7	Prussian
AV1	Black
AA3	Anthracite Grey
AN9	Slate
ARN	Silver
ASC	Steel Silver
AG8	Regent
AG9	York
AV4	Goose Grey
AV7	Light Grey
AB8	Portland
BA5	Traffic White

Laminate Finish Colours

Code	Colour Name
562	White
006	Maple
616	Beech
645	Walnut

Code	Colour Name
018	Oak
019	Cherry
529	Shorewood

Finishes for round wood handle and wooden dowell leg

Code	Colour Name
847	Light
807	Medium
808	Dark

Light (847) is a best match to Beech, Maple and White laminate finish colours – Medium (807) is a best match to Oak and White laminate finish colours – Dark (808) is a best match to Cherry, Walnut and White laminate finish colours.

Shorewood (529) not recommended with round wood handle or wooden dowel leg option.

6. **Cupboard door fronts** – select from 33 paint colours from the Vision colour palette or 7 laminate finishes.
Please note internal shelves in the cupboards will be the same finish as the carcass.
7. **Drawer fronts** – select from 33 paint colours from the vision colour palette or 7 laminate finishes. (Option to specify the top drawer in a different steel/laminate finish and/or add an AB key lock to the top drawer).
8. **Shelf modules** – all shelves will be the same finish as the carcass.
9. **Seat unit** – choose from over 100 fabric finishes (see step 14).

Optional Accessories

10. **Decorative top** – select from 7 laminate finishes.
11. **Decorative planter top** – decorative planters are dual finish. Please ensure you choose a paint colour for the **planter body** and a laminate finish for the **planter wrap**.
12. **Steel box inserts** – select from 33 paint colours from the Vision colour palette.
13. **Fabric back panels** – standard fabric ranges include Camira Synergy and Camira Blazer.
14. **Fabric seat pad** – Camira Synergy and Camira Blazer.
15. **Leather seat pad** – Futura. Please contact your Bisley Representative for a full list of leather options.

RANGE OVERVIEW

Bases (aerial view)



Modules (400mm wide)

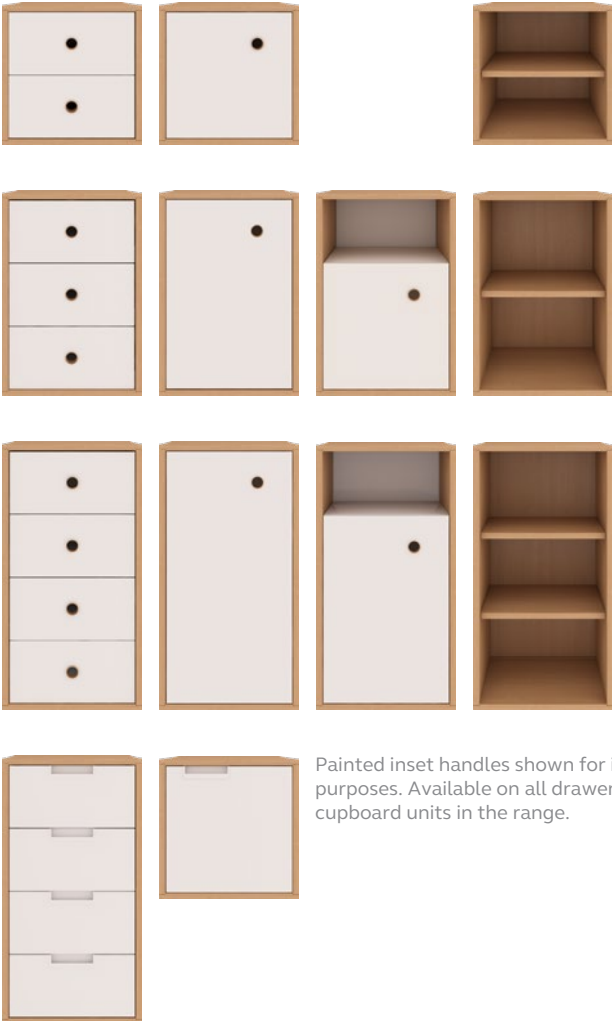

Painted inset handles shown for illustrative purposes. Available on all drawer and cupboard units in the range.

Legs



Handles



Modules (800mm wide)



INTERNAL DIMENSIONS GUIDE

Carcase

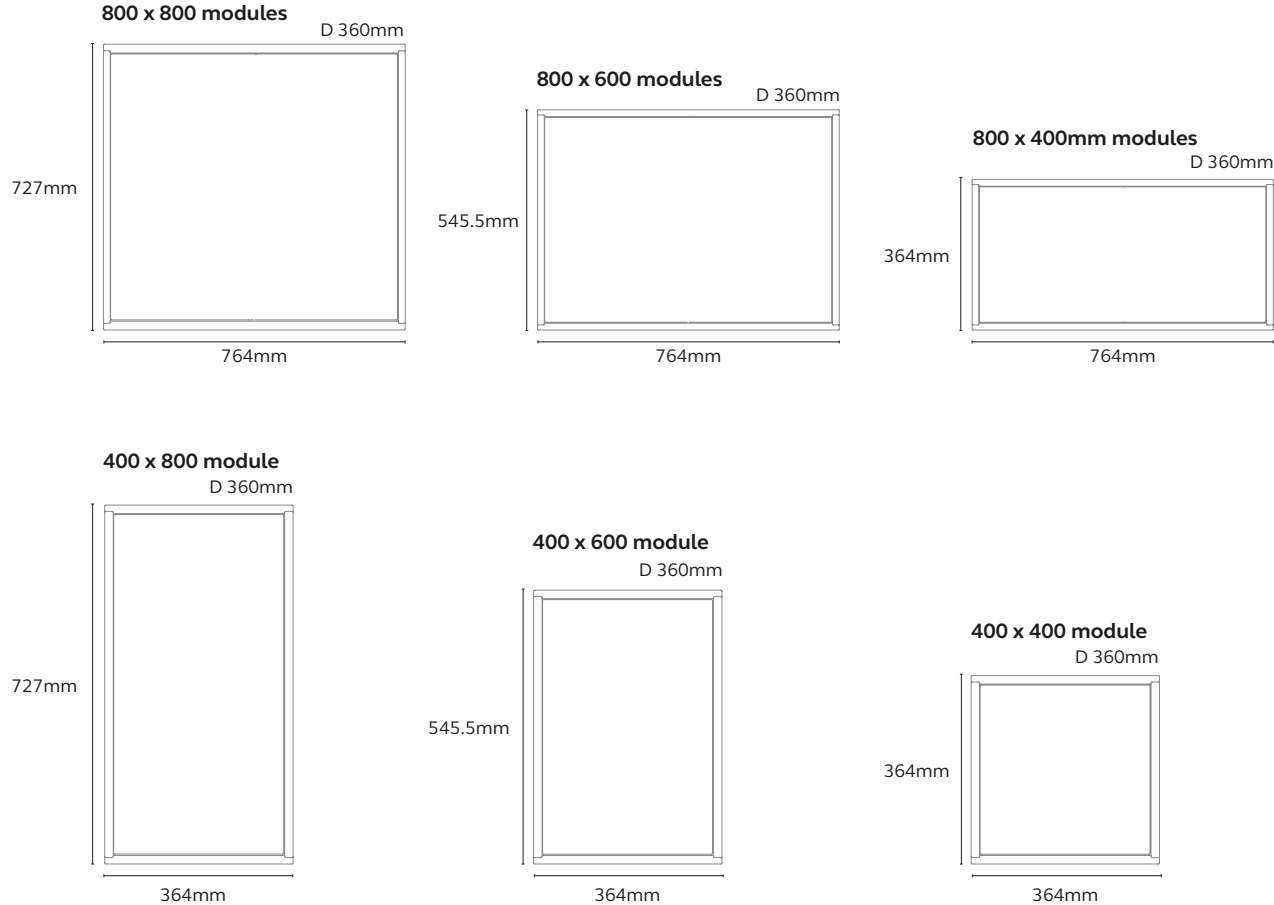

Drawer internal sizes

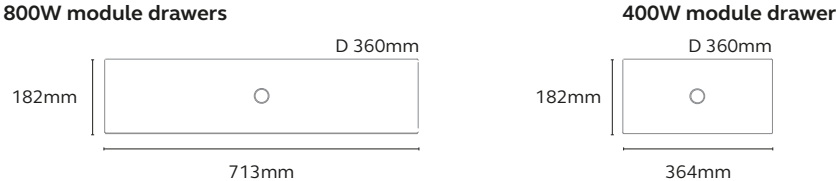

Cupboard internal sizes

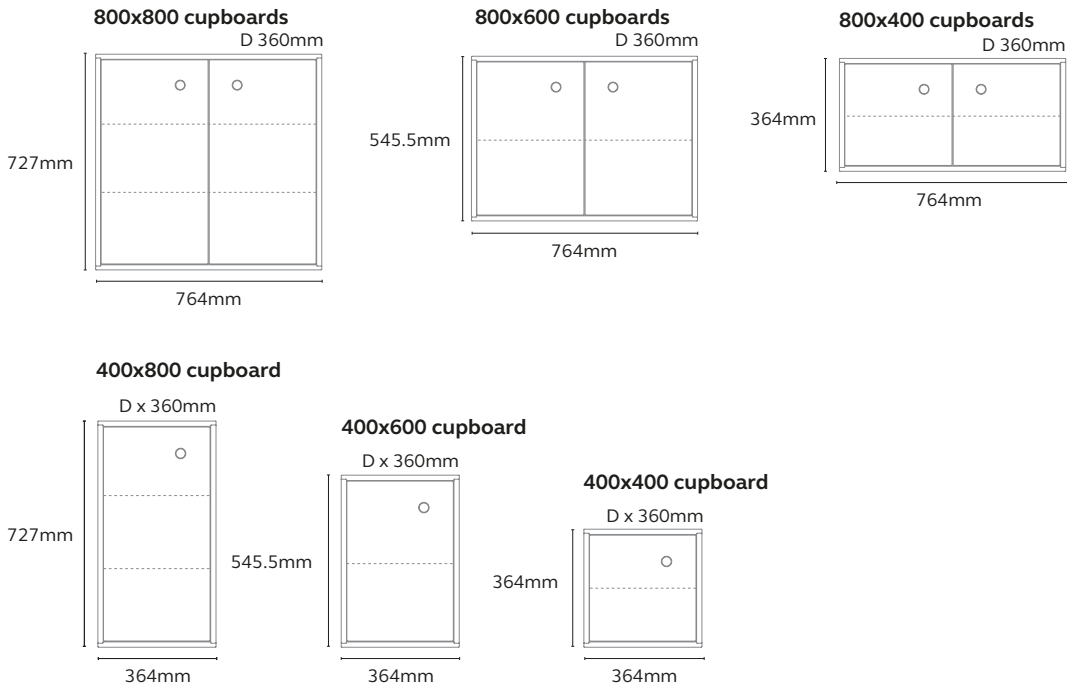

Shelves for shelf and cupboard modules

800x800 shelf unit

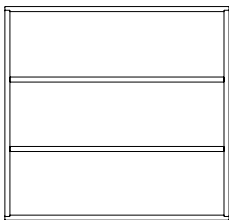

800mm high modules have 2 shelves with 5 shelf positions

800x600 shelf unit

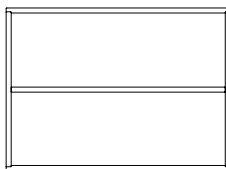

600mm high modules have 1 shelf with 3 shelf positions

800x400 shelf unit

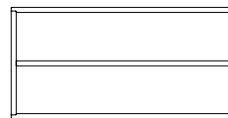

400mm high modules have 1 shelf

Please note shelves are adjustable in both shelf and cupboard modules.

Bridge's versatility connects the workplace with the ability to provide multiple functions in multiple spaces. Bridge can be used as an unobtrusive space divider, a meeting room credenza, a 'skyline' style welcome setting, or a spontaneous breakout area.

From a smart, stylish meeting room to an inviting characterful reception, Bridge effortlessly complements any workspace or meeting room, navigating you through your working day.

Visit www.bisley.com to find out more, or contact your Bisley representative.

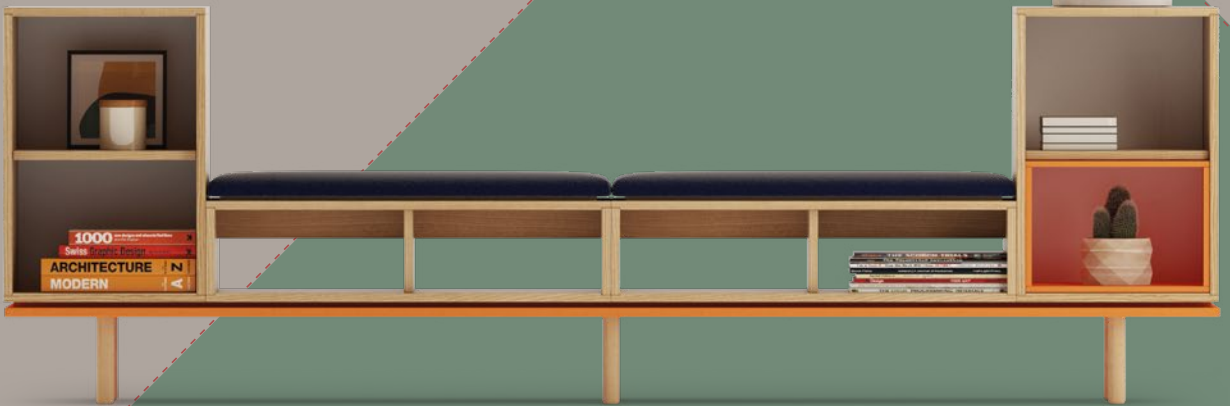

Versatile solutions that help your workday flow.

