

TWIST

ACTIU



**FRIGERIO DESIGN GROUP | FDG**

Enrico Frigerio

[www.frigeriodesign.it](http://www.frigeriodesign.it)

“Three key qualities for a workstation: functional, flexible and recyclable. A modular furnishing system which responds to the requirements of contemporary work. Quality spaces designed from a perspective of intelligent work”. Enrico Frigerio of Frigerio Design Group.

“Tres claves para un puesto de trabajo: funcional, flexible y reciclable. Un sistema de mobiliario modular que responde a las exigencias del trabajo contemporáneo. Espacios de calidad desde una perspectiva de trabajo inteligente”. Enrico Frigerio de Frigerio Design Group.

“Voici trois clés pour un poste de travail : fonctionnalité, flexibilité et durabilité. Un système de mobilier modulaire qui répond aux exigences du travail contemporain. Espaces de qualité depuis une perspective de travail intelligente”. Enrico Frigerio de Frigerio Design Group.

“Drei Schlüsselwörter für einen Arbeitsplatz: funktionell, flexibel und recyclebar. Ein modulares Einrichtungssystem, das den modernen Arbeitsansprüchen entspricht. Qualitätsräume aus einer intelligenten Arbeitssicht.” Enrico Frigerio, Frigerio Design Group.



**VISUAL LIGHTNESS AND STRUCTURAL ROBUSTNESS**

Twist offers a variety of configuration options which lend balance, rhythm, lightness and flexibility to the office. Part of a solid aluminium structure, composed of a steel central frame with legs that are attached using an aluminium injection assembly system which uses only one screw per leg. From this base point there are a range of options which can include up to three workstations in each individual structure.

Twist ofrece multitud de opciones de configuración que aportan agilidad, ritmo, frescura y flexibilidad a la oficina. Parte de una estructura sólida de aluminio, compuesta por un marco de acero central al que se unen las patas a partir de un sistema de ensamblado de inyección de aluminio que emplea un único tornillo por pata. A partir de ahí se despliegan las posibilidades del programa que puede incluir hasta tres puestos de trabajo en una misma estructura.

Twist propose de nombreuses options de configuration offrant agilité, rythme, fraîcheur et flexibilité au bureau. La base est une structure solide en aluminium, composée d'un cadre central en acier sur lequel les pieds s'assemblent à partir d'un système de montage en injection d'aluminium qui utilise une seule vis par pied. Cette configuration déploie les possibilités du programme qui peut inclure jusqu'à trois postes de travail dans une seule et même structure.

Twist bietet eine Vielzahl von Gestaltungsoptionen, die Gewandtheit, Rhythmus, Frische und Flexibilität zum Büro beitragen. Die Grundlage ist eine solide Aluminiumstruktur mit einer zentralen Stahltraverse, an der die Tischbeine mit einem einfachen Montagesystem durch eine einzige Schraube an das Gestell montiert werden. Dies ermöglicht eine Vielfalt von verschiedenen Kombinationen und bis zu drei Arbeitsplätzen an einem Gestell.

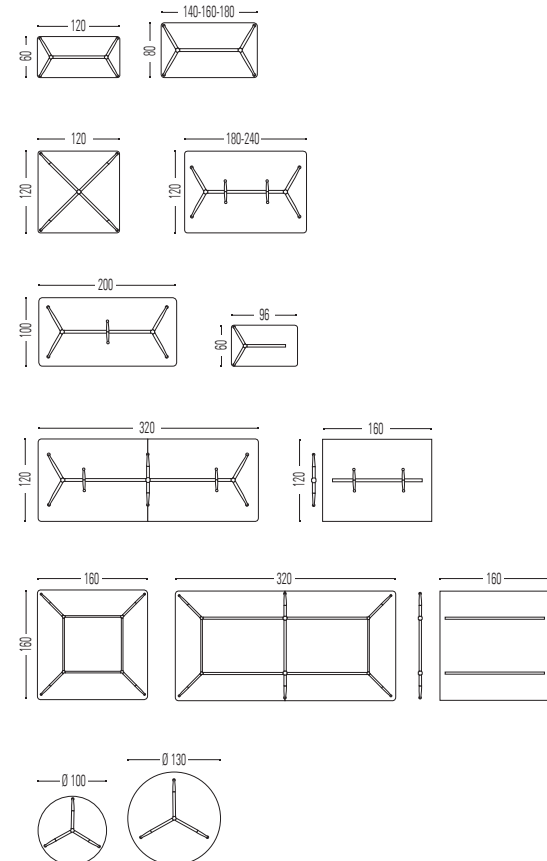





With its organic structure and unique aesthetic, Twist Spine is a model which has been designed for a new style of offices: active, organically growing, adaptable and functional, with an easy-to-reach filing system and an optimum cable management system. Twist's unique design combines visual lightness and a structural robustness.

Con su estructura orgánica y su estética diferenciadora, Twist Spine es un modelo pensado para las nuevas oficinas: activas, de crecimiento orgánico, moldeables y operativas, con archivos de proximidad y una óptima gestión del cableado. Twist aúna ligereza visual y robustez estructural en un diseño diferenciado.

Doté d'une structure organique et d'une esthétique distinctive, Twist Spine est un modèle pensé pour les nouveaux bureaux: actifs, à croissance organique, adaptables et opérationnels, munis de classeurs à proximité et d'un câblage qui bénéficie d'une gestion optimale. Twist allie la légèreté visuelle à la robustesse structurelle, et il est doté d'un design distinctif.

Mit einer organischen Struktur und einer unverwechselbaren Ästhetik ist das Twist Spine Modell für moderne Büros gedacht: aktiv, organisch wachsend, verformbar und wirksam, mit leicht erreichbaren Aktenschränken und optimal durchdachter Verkabelung. Twist vereint in sich die visuelle Leichtigkeit und die strukturelle Robustheit in einem einzigartigen Design.

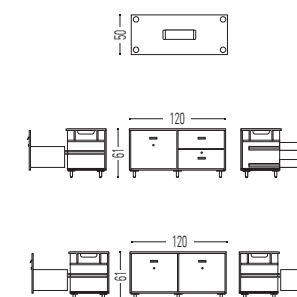
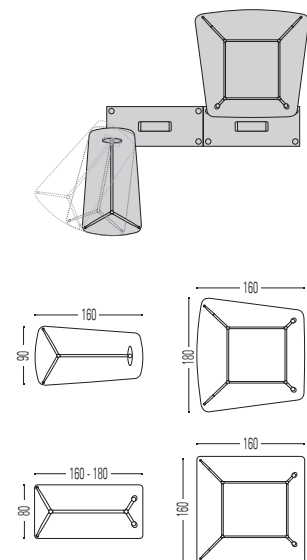
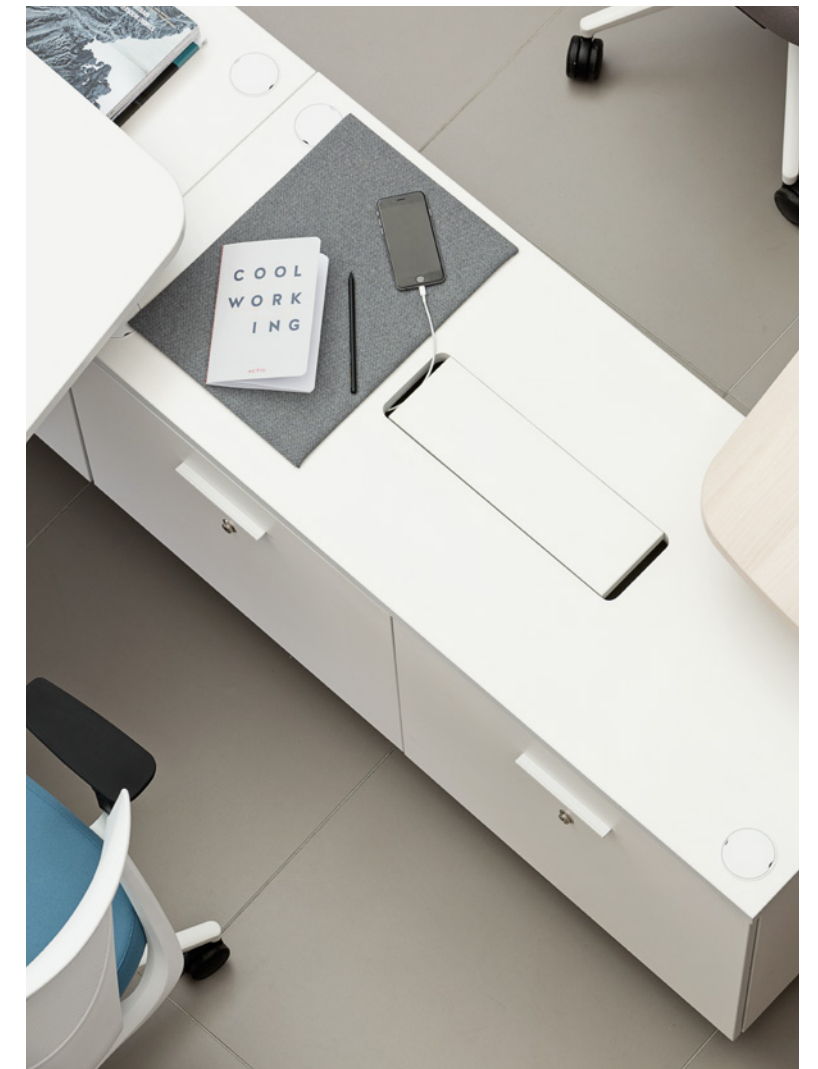



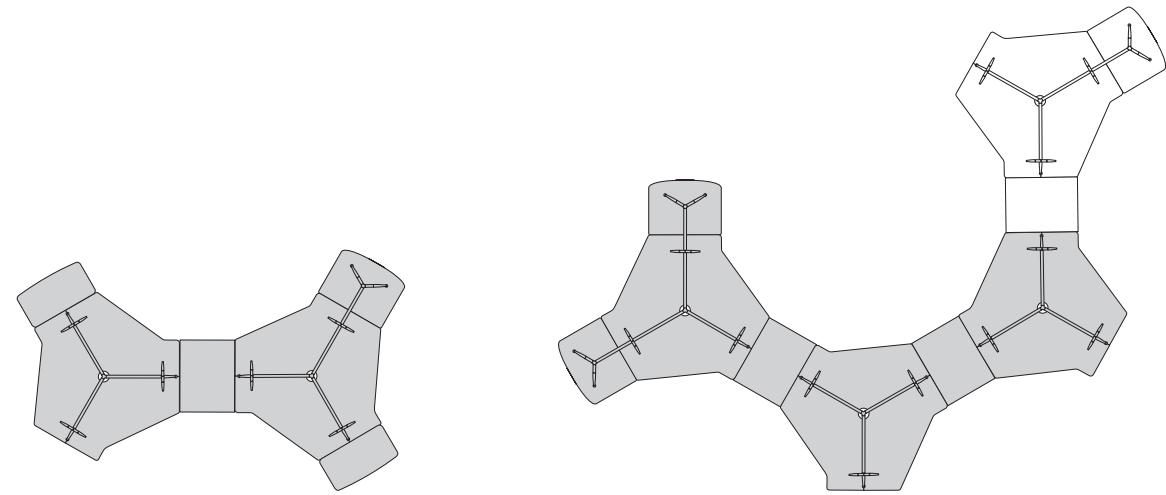

■ Within the wide range of possible configurations, there is the option of using pivoting GEN tables. The position and orientation of these tables can be installed within a twist of almost 360 degrees. This style is extremely practical for hot-desking and informal meetings and helps to facilitate cooperation between professionals.

Dentro de la variada gama de configuraciones posibles, existe la opción de mesas GEN oscilantes, cuya posición y orientación puede instalarse dentro de un giro de casi 360 grados. Se trata de una variable muy práctica para hotdesking, para reuniones informales y para facilitar la cooperación entre profesionales.

Parmi la gamme variée des configurations possibles, il existe l'option des tables GEN pivotantes, qui peuvent être orientées et positionnées sur un rayon de presque 360 degrés. Cette variante est particulièrement adaptée au hotdesking et aux réunions informelles, tout en facilitant la coopération entre professionnels.

Innerhalb des großen Gestaltungsspektrum gibt es die Option schwingender GEN Tische, die in einem Winkel von fast 360° positioniert und orientiert werden können. Es handelt sich um eine ganz praktische Variable für das Hot Desking, für informelle Meetings, und um die Zusammenarbeit zu fördern.

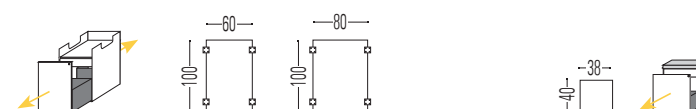



■ Twist combines connectivity and technology at the work desk. The furniture consolidates technology and internet connection in a simple and natural manner, in this way reinterpreting the working environment. Efficiency of space, collaboration and the proximity of users are the reason d'être of this range. It encourages connection between tables, creating offices with a more fluid visual effect. Its unique assembly system makes it extremely efficient to install.

Twist integra la conectividad y la tecnología en la mesa de trabajo. Concentra en el mobiliario tecnologías y conexión a internet de forma sencilla y natural, reinterpretando el entorno laboral. La eficiencia del espacio, la colaboración y la proximidad del usuario son la razón de ser de este programa. Favorece la conexión entre mesas creando oficinas más fluidas visualmente. Su sistema único de ensamblaje potencia la eficiencia de la instalación.

Twist intègre sur sa table de travail connectivité et technologie. Cette ligne concentre dans le mobilier les technologies et la connexion internet d'une manière simple et naturelle qui réinterprète l'environnement professionnel. La rentabilité de l'espace, la collaboration et la proximité de l'utilisateur représentent la façon d'être de ce programme. Il favorise la connexion entre les tables, ce qui crée des bureaux plus fluides en termes de visibilité. Son système d'assemblage est unique et renforce l'efficacité de l'installation.

Twist integriert die Konnektivität und die Technologie am Arbeitsplatz. Das Tischprogramm konzentriert Technologien und Internetverbindung an dem Mobiliar auf eine einfache und natürliche Weise, wobei das Arbeitsumfeld neu interpretiert wird. Die Raumeffizienz, die Zusammenarbeit und die Nähe des Benutzers sind der Grund, warum dieses Programm optimal für das moderne Büro ist. Es vereinfacht die Verbindung zwischen den Tischen, wodurch ein flüssiges Bürobild geschaffen wird. Sein einzigartiges Montagesystem steigert die Einrichtungseffizienz.

TWIST GEN 80

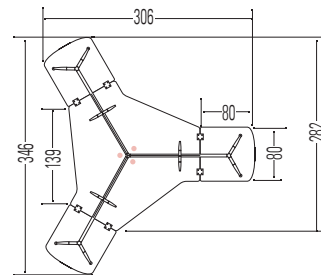
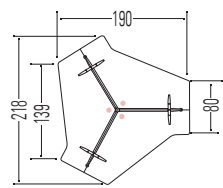

TWIST GEN 100

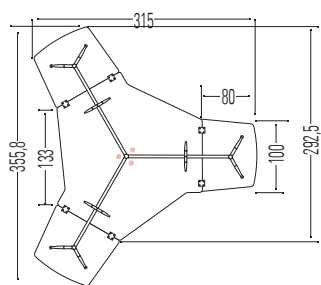
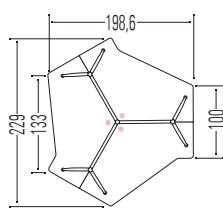





Among the innovative contributions of Twist are its trapezoid desks, which are available in a standard height or in a higher height for working in a standing position or sitting on a stool. This makes the desks perfect for presentations, videoconferences and online meetings since it means that the entire screen can be seen from any angle by the people using it.

Una de las aportaciones innovadoras de Twist son las mesas trapezoidales, disponibles en altura estándar o más alta -para trabajar de pie o sobre taburete- ideales para presentaciones, videoconferencias y reuniones online ya que permite la visión completa de la pantalla desde cualquier ángulo a todas aquellas personas que la estén usando.

Les tables trapézoïdales représentent l'un des apports novateurs de Twist. Elles sont disponibles en hauteur standard ou à une hauteur supérieure pour le travail debout ou assis sur un tabouret – une configuration idéale pour les présentations, les vidéoconférences et les réunions en ligne, car elle permet une vision complète de l'écran pour tous les utilisateurs, depuis tous les angles de la pièce.

Eine von Twist präsentierte Innovation sind die trapezförmigen Tische, verfügbar in Standardhöhe oder größer – um stehend oder sitzend zu arbeiten – ideal für Präsentationen, Videokonferenzen und Online-Meetings, da das der Bildschirm aus jedem Winkel für alle teilnehmenden Personen perfekt sichtbar ist.

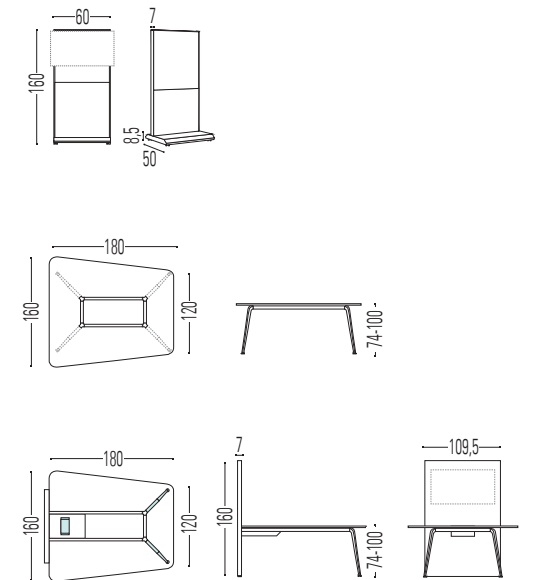



**ACTIU TECHNOLOGY PARK**

Architecture linked to the local industry.  
A philosophy turned into architecture.  
Architect: José María Tomás Llavador.

**DESIGN & ARCHITECTURE**

Space management and design  
Products. Own patents  
Communication

**SUSTAINABILITY**

Sustainable production  
Product. Eco-design  
Services, efficient logistics system  
Actiu Technology Park, certified LEED® Platinum

**MANUFACTURER**

We are manufacturers  
Domain raw materials and processes  
Technology and Innovation  
Standardized and specific solutions

**GLOBAL COVERAGE**

Presence in more than 90 countries  
Global equipment solutions. Corporate, Health,  
Education, Contract, Transport.

**CERTIFICATES AND REFERENCES**

ACTIU products fulfill all demands about management, quality and sustainability to provide extra value to the projects using recycled materials to get the recyclable final product.



**ACTIU TECHNOLOGY PARK**  
LEED® PLATINUM certified by USGBC  
Leadership in Energy & Environmental Design  
LEED® Gold certified 2011 - LEED® Platinum certified 2017



**ACTIU: 50 YEARS DESIGNING PUBLIC SPACES AND WORKSPACES.**  
Actiu is an industrial company working within the installation sector and specialising in the manufacture of furniture. Actiu's flexibility and productive capacity enable the company to carry out comprehensive equipment projects worldwide, providing solutions that favour the wellbeing of people.

**ACTIU, 50 AÑOS DISEÑANDO ESPACIOS PÚBLICOS Y DE TRABAJO.**  
Actiu es una empresa con una trayectoria industrial en el sector de la instalación, especializada en la creación de mobiliario, cuya flexibilidad y capacidad productiva permite desarrollar proyectos de equipamiento global a nivel internacional aportando soluciones que ofrezcan el bienestar de las personas.

**ACTIU, 50 ANS DE CONCEPTION D'ESPACES PUBLICS ET DE TRAVAIL.**  
Actiu est une entreprise dotée d'un parcours à caractère industriel dans le secteur de l'installation, qui se spécialise dans la création de mobilier, et dont la flexibilité et la capacité de production permettent de développer des projets d'équipement global à un niveau international, tout en apportant des solutions qui puissent offrir du bien-être aux personnes.

**ACTIU, 50 JAHRE DESIGN UND PRODUKTION VON MÖBELN FÜR ÖFFENTLICHE EINRICHTUNGEN UND ARBEITSRÄUME.**  
Unsere ständige Forschung, Weiterentwicklung, Flexibilität und Erfahrung ermöglichen es uns, Projekte im privaten und öffentlichen Bereich der verschiedensten Sektoren auf nationaler und internationaler Ebene durchzuführen. Stillstand ist uns fremd. Uns treibt das Bedürfnis an, näher an den Menschen zu sein und Lösungsmöglichkeiten zu entwickeln, die den Endnutzern Wohlgefühl bieten.

ACTIU reserves the right to carry out technical, dimensional and finishing modifications that it considers appropriate with respect to the information detailed in this document, so please check before confirming your orders.

ACTIU se reserva el derecho de llevar a cabo las modificaciones técnicas, dimensionales y de acabados que estime conveniente respecto a la información detallada en este documento, por el que se ruega verificación antes de confirmar sus pedidos.

We dream to go beyond our own immediate reality. We design to mature our desires. We walk because only our initiative changes the world and breaks new ground. We move ourselves by being ourselves without the fear of underperforming against our own expectations and goals.

**D. Vicente Berbegal Pérez**  
President and Founder of the Actiu Group.

**European Entrepreneur of the year 2017**  
European Business Awards



ACTIU, National Design Award 2017  
ACTIU, Premio Nacional de Diseño 2017

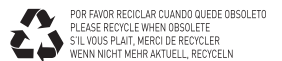

# TWIST

Wooden structure

— Design Enrico Frigerio by FDG —



■ **TWIST OPERATIVE**

STRAIGHT DESKS

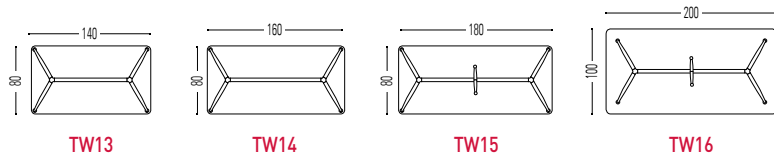

RETURNS

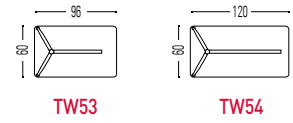

TWIN & MEETING DESKS

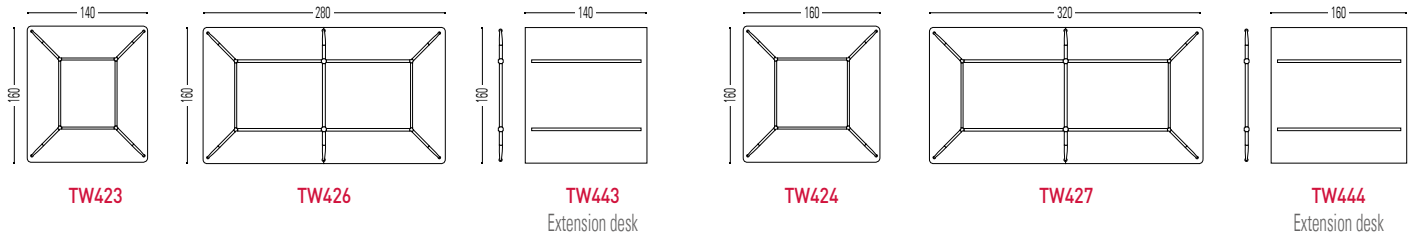

MEETING TABLES

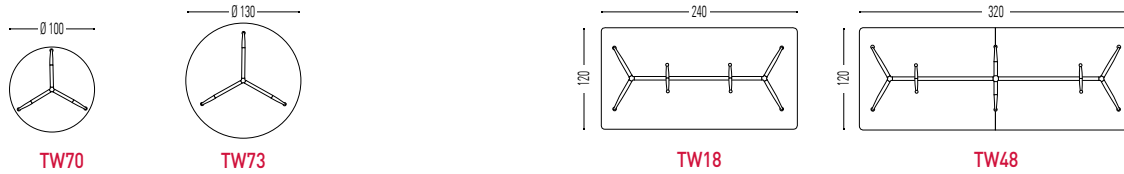

MEETING TABLES 100 CM HEIGHT

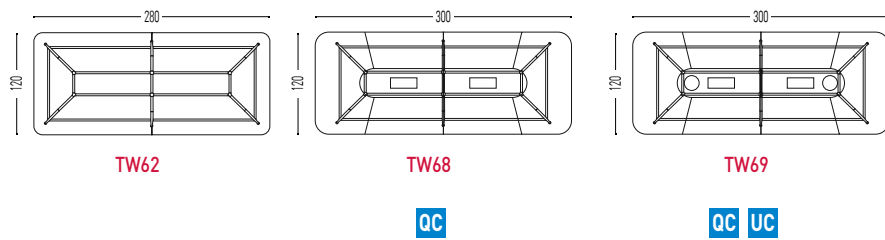

■ **TWIST - GEN 100**

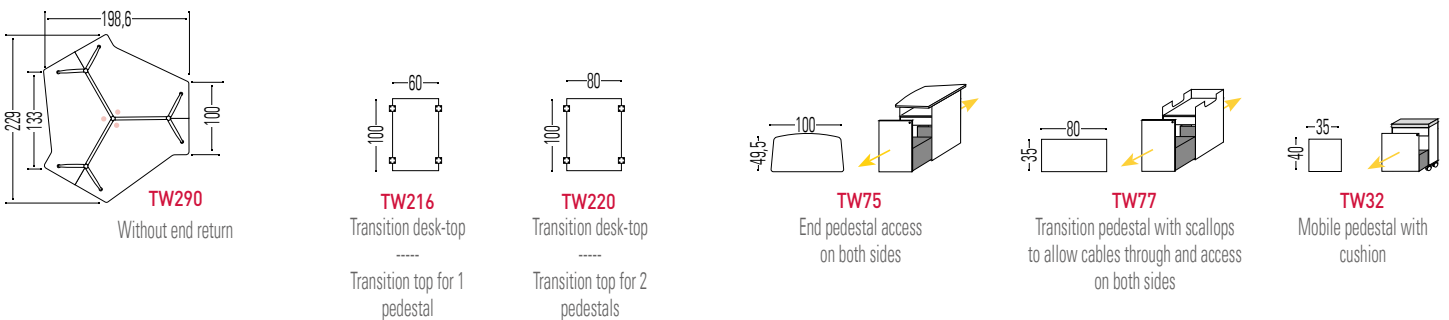

■ **TWIST VIDEO-CONFERENCE**

VIDEO-CONFERENCE UNIT: 74 cm HEIGHT WITH SCREEN TO ALLOCATE MONITOR

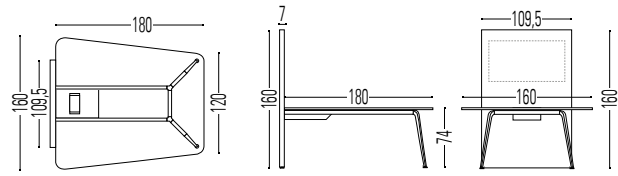

**TW97**

VIDEO-CONFERENCE UNIT: 100 cm HEIGHT WITH SCREEN TO ALLOCATE MONITOR

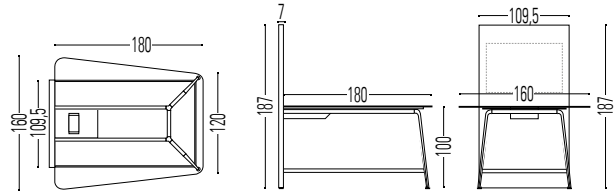

**TW91**

VIDEO-CONFERENCE TABLE 74 cm HEIGHT

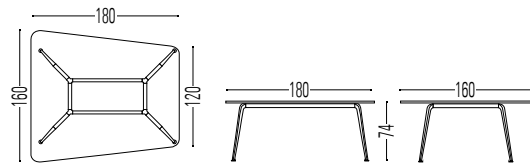

**TW495**

VIDEO-CONFERENCE TABLE 100 cm HEIGHT

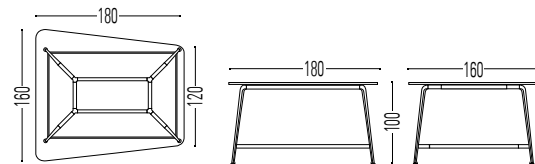

**TW496**

■ **TWIST SPINE**

DESK SUPPORTED TO SPINE - LINEAR MODULES

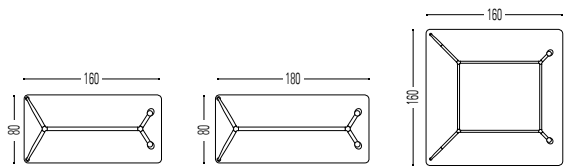

**TWSL24 / TWSR24**

**TWSL25 / TWSR25**

**TWS444**

Desk supported to Spine credenza

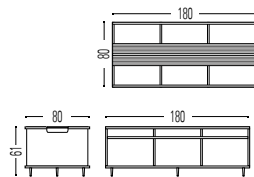

**E25**

Double Module Compartment  
Continuous Electrifications

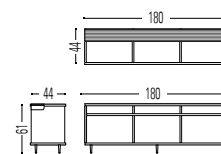

**E15**

Single Module Compartment  
Continuous Electrifications

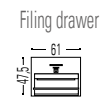

**E177**

Front Accessories for single and double  
modules



**E175**

## TWIST - BEECH WOOD LEGS - Individual desks, Twin desks and Meeting tables

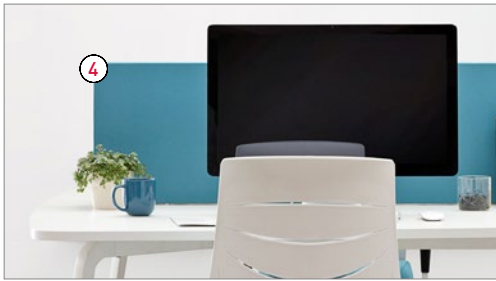

### ■ FEATURES

- ① Beech wood legs with black straps, offering big frame stability and lightness which allows a very distinguished esthetic.
- ② 50x40mm warm rolled steel frame profile 2 mm thick, with a new system for quick assembling allowing a very strong stability by using minimum quantity of screws.
- ③ Table surface made out of 25mm MFC with round corners. 2mm thick edge.
- ④ Several screen options available (see accessories).
- ⑤ Several cable managing options available (see accessories).
- ⑥ PP levellers with anti-skid pad.

**TWIST - BEECH WOOD LEGS** - Individual desks, Twin desks and Meeting tables**■ FEATURES**

- ① Beech wood legs with black straps, offering big frame stability and lightness which allows a very distinguished esthetic.
- ② 50x40mm warm rolled steel frame profile 2 mm thick, with a new system for quick assembling allowing a very strong stability by using minimum quantity of screws.
- ③ Table surface made out of 25mm MFC with round corners. 2mm thick edge.
- ④ Cable tray included.
- ⑤ Models with or without cable managing options.
- ⑥ PP levellers with anti-skid pad.

## TWIST - GEN



### ■ FEATURES

- ① Beech wood legs with black straps, offering big frame stability and lightness which allows a very distinguished esthetic.
- ② 50x40mm warm rolled steel frame profile 2 mm thick, with a new system for quick assembling allowing a very strong stability by using minimum quantity of screws.
- ③ 120 degree tops which allow linking desks and create a very new working concept. Table surface made out of 25mm MFC with round corners. 2mm thick edge.
- ④ Several screen options available (see accessories).
- ⑤ Several cable managing options available (see accessories).
- ⑥ PP levellers with anti-skid pad.
- ⑦ Ending MFC pedestal with both sides access.
- ⑧ Steel mobile pedestals with castors. Top cushion available in a wide range of fabrics.
- ⑨ Middle extension / desk return / meeting table.

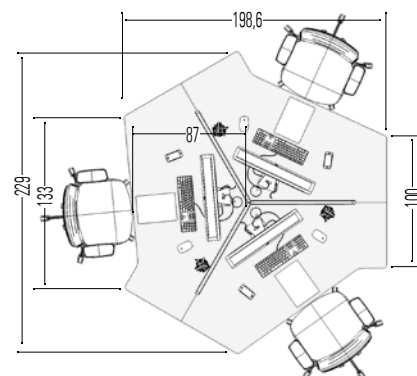



## TWIST - SPINE



### ■ SPINE FEATURES

- ① Filing cabinet support available for single and twin desks. Trapezoidal top's shape.
  - ② Beech wood legs with black straps, offering big frame stability and lightness which allows a very distinguished esthetic.
  - ③ 50x40mm warm rolled steel frame profile 2 mm thick, with a new system for quick assembling allowing a very strong stability by using minimum quantity of screws.
  - ④ Table surface made out of 25mm MFC with round corners. 2mm thick edge.
  - ⑤ Double access for cables allows using it by two sides (optional).
  - ⑥ Several screen options available (see accessories).
  - ⑦ Several cable managing options available (see accessories).
  - ⑧ PP levellers with anti-skid pad.
- 
- ① MFC filing cabinet. The frame is made of 19mm melamine. Two models are available:
    - Individual module: 180 x 40 x 61 cm - Compartment using one side.
    - Double module: 180 x 80 x 61 cm - Compartment using 2 sides.
  - ② Interior shelves 19 mm melamine.
  - ③ Top cover in 25 mm melamine, veneered soft edges for added safety and durability.
  - ④ 2 models of reversible fronts: Sliding melamine 16 mm door and Filing drawer with metal tray and melamine 16 mm front.
  - ⑤ Hollow interior for continuous electrification with access to it from the top using folding doors.
  - ⑥ Die Cast aluminum feet with PVC anti-skid pad.

TWIST - VIDEO-CONFERENCE

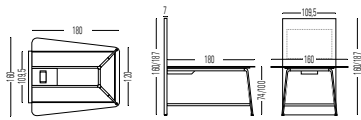

**1** Maximum weight and sizes

TV

65"

maximum

■ FEATURES

- ① Beech wood legs with black straps, offering big frame stability and lightness which allows a very distinguished esthetic.
  - ② 50x40mm warm rolled steel frame profile 2 mm thick, with a new system for quick assembling allowing a very strong stability by using minimum quantity of screws.
  - ③ Trapezoidal top allows all users to be more connected and closed during meetings. Table surface made out of 25mm MFC with round corners. 2mm thick edge.
  - ④ Steel footrest finished in Chrome (always) - **only for 100cm height desks.**
  - ⑤ Several cable managing options available (see accessories).
  - ⑥ PP levellers with anti-skid pad.
- 
- ① MFC with aluminium frame "TV" panel fixed on table. "TV and wiring not included".
  - ② PP levellers with anti-skid pad for fixed TV Panel.

Optional connexion:

**3 SCREEN WITHOUT POWER FRAME**

It includes:

- **EU:** 3 power modules - GX30 + Cable with Power GX21
- **UK:** 3 power modules - GX30L + Cable with Power GX21L
- **US:** 3 power modules - GX30D + Cable with Power GX21D

- 2 USB- 3.0 elbow
- 2 HDMI elbow
- 4 adhesive support for cables
- 1 screw kit

**SCREEN WITH POWER FRAME**

It includes:

- **EU:** 3 power modules - GX30 + Cable with Power GX21
- **UK:** 3 power modules - GX30L + Cable with Power GX21L
- **US:** 3 power modules - GX30D + Cable with Power GX21D

- 2 USB - 3.0 elbow
- 2 HDMI elbow
- 4 adhesive support for cables
- 1 screw kit
- Power Frame - 2 types:
  - **For Dedicated CPU**  
- 2 USB - 3.0 + HDMI + Power
  - **Without Dedicated CPU**  
- HDMI + 2 powers

- ④ Fixing points for monitors as per VESA 200, 300 and 400.  
Interior fixing points for CPU (As per VESA 75 and 100).

**NOTE: Computers and/or Televisions are not included in the price.**

TWIST - VIDEO-CONFERENCE - ELECTRONIC DEVICES

**SCREEN WITHOUT POWER FRAME**

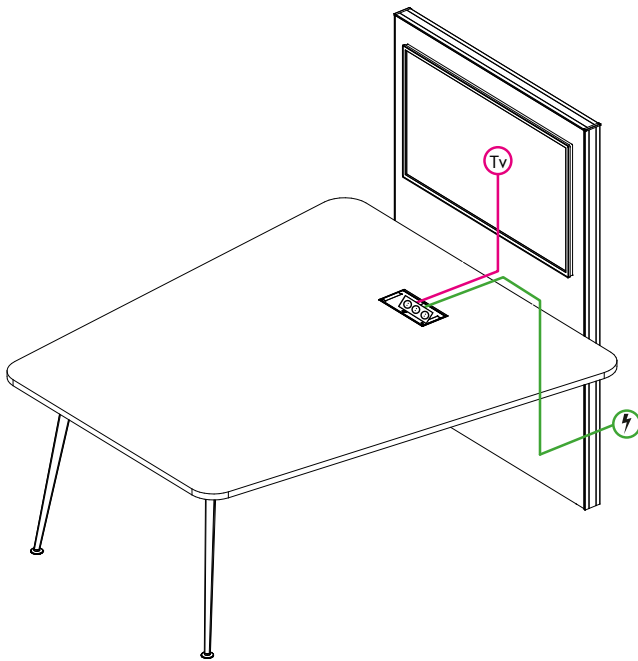



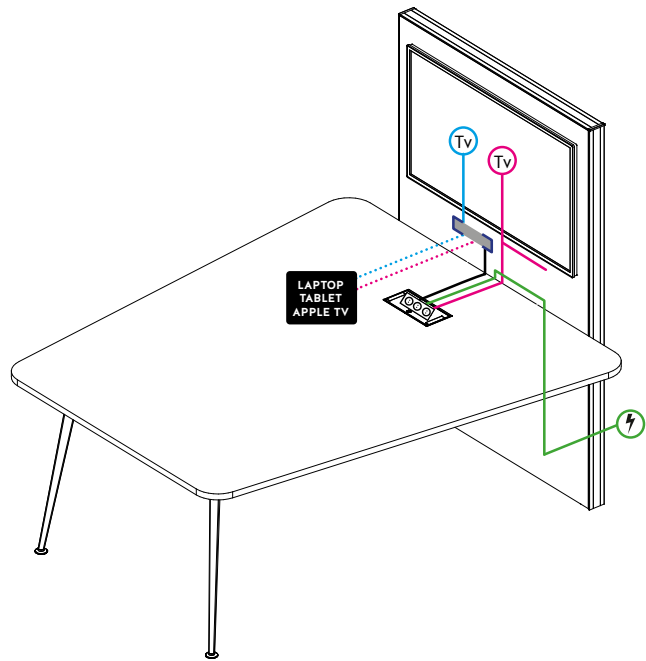



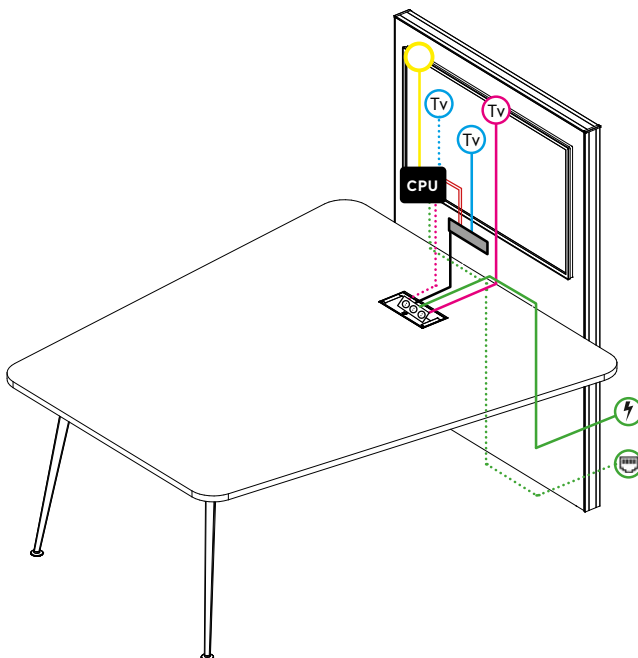



**SCREEN WITH POWER FRAME  
NO CPU  
(HDMI + SCHUKO)**

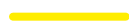

**SCREEN WITH POWER FRAME  
WITH CPU (not included)  
(HDMI + USB + SCHUKO)**



• **CAPTION**

-  HDMI 1 (This cable connects TV to Power frame)
-  HDMI 2 (This cable connects TV to CPU)
-  TV ELECTRICITY (this cable connects TV to electricity)
-  CPU ELECTRICITY (this cable connects CPU to electricity)
-  USB - 2 UDS. (These cables connect CPU with power frame)
-  WEBCAM (This cable connects webcam with CPU)
-  GENERAL ELECTRICITY (This cable connects multiple connector to electricity)
-  CABLE RED (This cable connects CPU to Ethernet point)
-  PF ELECTRICITY (This cable connects power frame to GX30)
-  GX30 (Located where power frame is connected, tv and the CPU electricity, in the panel)
-  POWER FRAME: USB [2ud] + HDMI [1ud] + Shuko [1ud]. (Devices are connected outwardly. HDMI of the tv and 2 USB are connected to CPU inwardly).

■ **CABLE MANAGEMENT**

Twist is available with several cable management options.



Steel metal channel 0,8 mm to 1 mm thick, large capacity for double desks.



Steel metal channel 0,7 mm to 1 mm thick for individual desk.



Metallic cable box container.



Polystyrene cable riser.



Free standing metal cable riser.



Push Latch "T" access.



"U" Access.



Integrated "Q" access.



"R" access.

■ **SCREENS**

TWIST offers a big variety of screens: all upholstered panels, with aluminium tool rails allowing accessories, acoustic or glazed. TWIST also offers sliding and independent screens for desktops without any kind of fixation but with big stability.



Desktop fixed screens.



Free standing screen.

■ **MODESTY PANEL**



Metallic or MFC.

■ **CPU HOLDER**



CPU holder of 25-30 x 49 cm and 1,5 mm thick.

■ **FINISHES**

**Melamine**



00 White



03 Anti-finger Prints

**Estructure**



White / Beech



Black / Beech



**MATERIALS**

Maximum use of materials to eliminate and minimize scraps. Use of recyclable and recycled materials in those components that do not affect the functionality and durability.

**22,83%**  
RECYCLED  
MATERIALS



**PRODUCTION**

Maximum optimization of energy use. Minimal environmental impact. Last generation technological systems. Zero discharge of wastewater. No VOC coatings. Processes free of heavy metals, phosphates, OC and COD.

**100%**  
RECYCLABLE  
ALUMINIUM, STEEL  
& WOOD



**TRANSPORT**

Detachable systems. Volumes that facilitate the optimization of space. Maximum reduction of energy consumption by transport.

**100%**  
RECYCLABLE  
PACKAGE AND THINNER  
FREE



**USE**

Quality and warranty. Long lasting. Replacements available.

**EASY**  
TO CLEAN  
AND MAINTAIN



**DISPOSAL**

Waste reduction. Supplier-manufacturer packaging reuse system. Components are easy to be separated. Inks in packaging are water-based, without solvents.

**97,73%**  
RECYCLABLE  
MATERIALS

**■ CERTIFICATES AND REFERENCES**

The different programmes get points in different environmental categories to get the LEED certificate (sustainability, material and resources, water, energy and atmosphere, inner environment quality, innovation and design).



The mark of responsible forestry



EN ISO 14006:2011  
ECODESIGN Certificate



UNE-EN ISO 9001:2008  
ISO 9001 Certificate



UNE-EN ISO 14001:2004  
ISO 14001 Certificate



E1 Certificate  
by EN 13986



California 93120  
Compliance Formaldehyde Phase 2



ACTIU TECHNOLOGY PARK  
LEED® PLATINUM certified by USGBC  
Leadership in Energy & Environmental Design  
LEED® Gold certified 2011 - LEED® Platinum certified 2017

**■ STANDARDS**

TWIST has passed tests done in our technical department as well as the tests done in AIDIMA the Technological Institute for furniture. The tests correspond to UNE standards and office desks:

- **UNE: EN 527-1:2011.** Office Furniture. Desks. **Part 1:** Dimensions.
- **UNE: EN 527-2:2017.** Office Furniture. Desks. **Part 2:** Requirements for safety, resistance and durability.
- **UNE: EN 15372:17.** Office Furniture. Strength, durability and safety. Requirements for domestic use desks. Office Furniture. Desks.