

TECHNICAL FILE

Occasional tables

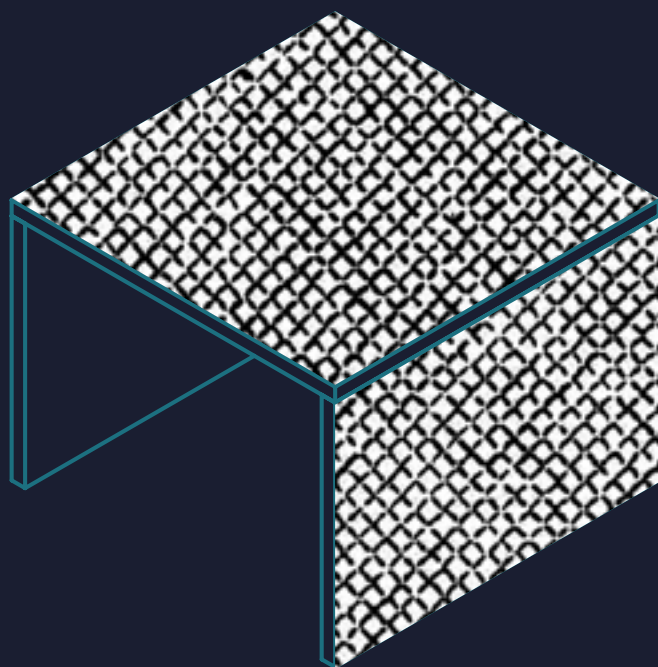

BOS
BARCELONA
— SINCE 1964 —

Occasional tables
TECHNICAL FILE

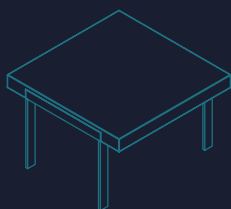

AVOCADO



AQUA

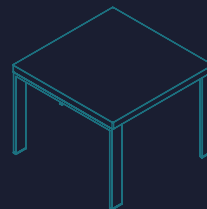

ODESSA



LEAD PLUS

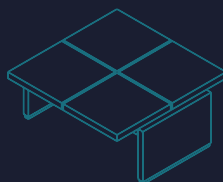

KARAN

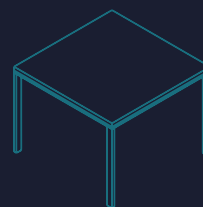

FORO

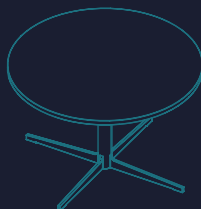

X64

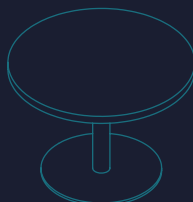

RODA

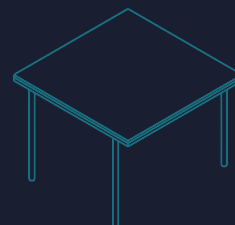

LA SCALA

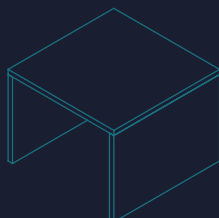

LEAD

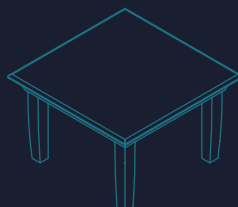

AVANT

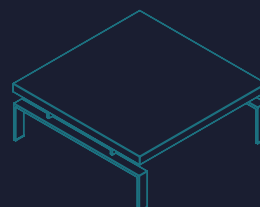

LEAD

Materials, Finishes & Quality

- Table top core is MDF Mediland quality LP classified as Class E1 according to European norm EN 622-1:2003 and density between 600-620KGS/m³ which is maximum in furniture appliance.
- To achieve the piano lacquer finish a thick layer of lacquer is applied which afterwards goes through a 10 years manual polishing process with wool.
- All pieces come with three layers of polish with **sanding by hand** between each layer to achieve an optimal smooth adherence and durability.
- The wooden parts are all **polished** with lacquers of polyurethane with high content of solids to build a greater hardness without losing the sensation of the wooden touch.
- The decorating elements are made by **laser cut stainless steel** finished by hand.
- The structures are made of steel given an **exclusive treatment** which consist of niquel bath, lacquered and polished by hand.
- All tables are **finished by hand**, pre-assembled in the factory, numbered one by one to guarantee a perfect assembly for the final client.
- **Unique packaging** in reticulated polyethylene foam, triple layer of laminate polyethylene with hermetic bubbles 5x5 and density of 5400 bubbles/m², corner protectors of high density reticulated polyethylene foam and cardboard box made to fit.



UNE-EN ISO
9001:2015

UNE-EN ISO
14001:2015

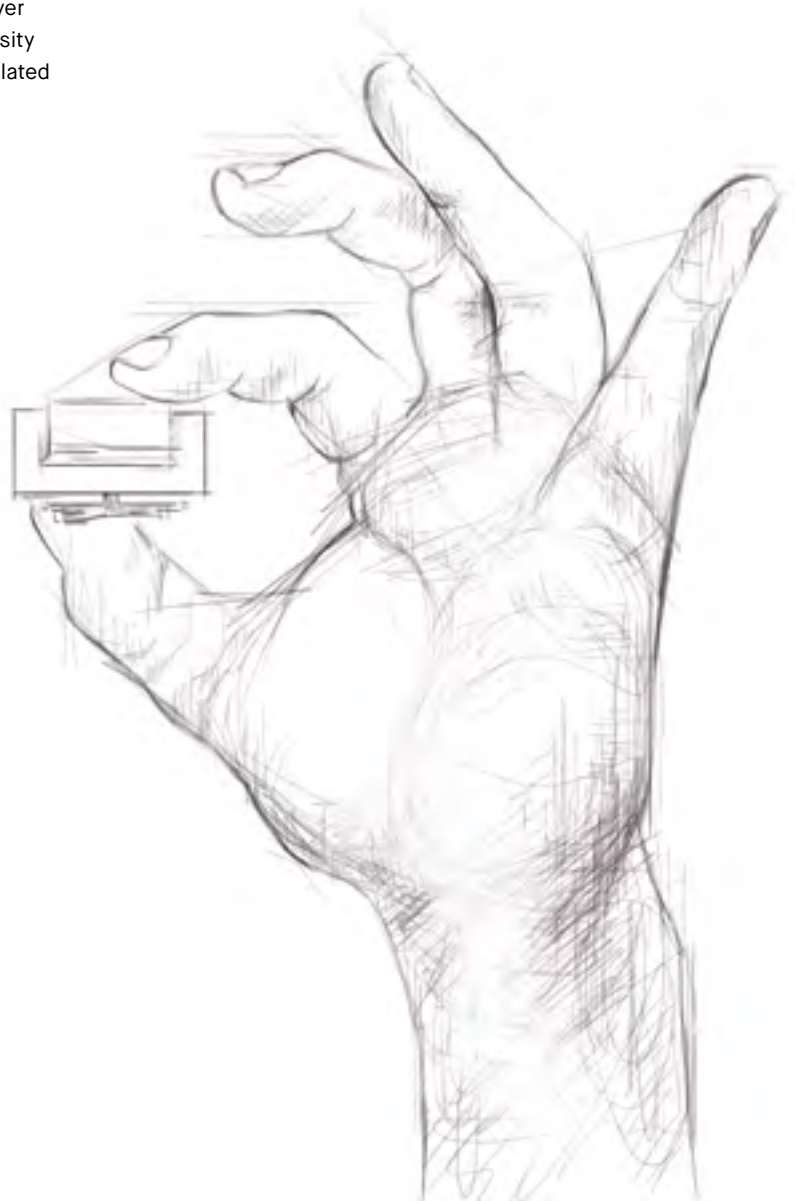

AVOCADO

TECHNICAL PRESENTATION

Dimensions

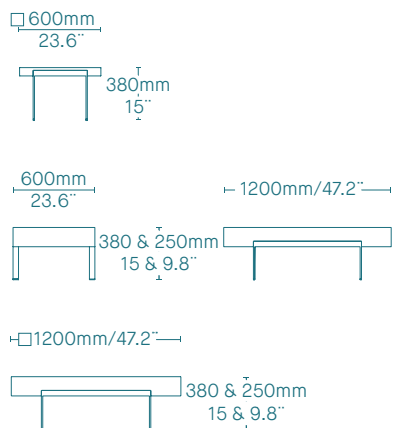





Table top

Thickness	Shape	Finishes
140mm 5.5"		Wood Lacquer
60mm 2.4"		

Structure

Shapes	Finishes
	Chromed

